

**COLOS**  
by OFFIHO®

**COLOS**  
by OFFIHO®

# Index / Index / Índice / Inhaltsverzeichnis

DAILY \_4



DAILY 1 DAILY 2

TORRE \_8



TORRE TORRE S TORRE 103

PIAZZA \_14



PIAZZA 1 PIAZZA 2 PIAZZA 3A PIAZZA 3B

VESPER \_20



VESPER 1 VESPER 2 VESPER 1SW VESPER 2SW VESPER 3A VESPER 3B VESPER PANCA

SPLIT \_32



SPLIT SPLIT GL SPLIT 1 SPLIT 3A SPLIT 3B SPLIT KIDS SPLIT 103

PIGRECO \_42



PIGRECO

RE-AL \_46



RE-AL 1 RE-AL 2

VILLA \_52



VILLA 1 VILLA 2 VILLA 3A VILLA CUS

C1 \_58



C 1.1/1 C 1.1/4 C 1.2/1 C 1.2/4

STECCA \_68



STECCA 1 STECCA 2 STECCA 5 STECCA 6 STECCA 7 STECCA 8 STECCAL

MOMO NET \_68



MOMO NET 1 MOMO NET 2 MOMO NET 3

ALFIERE \_74

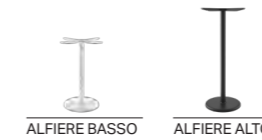

ALFIERE BASSO ALFIERE ALTO

STATO \_78



STATO BASSO STATO ALTO

EDGE \_82

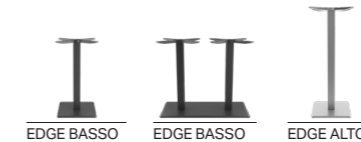

EDGE BASSO EDGE BASSO EDGE ALTO

TOPS \_89

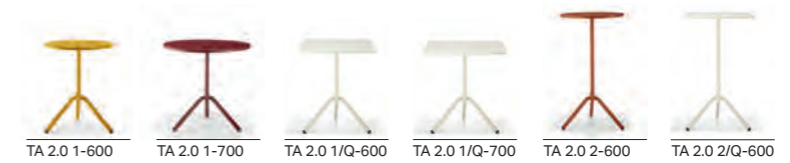

TA 2.0 1-600 TA 2.0 1-700 TA 2.0 1/Q-600 TA 2.0 1/Q-700 TA 2.0 2-600 TA 2.0 2/Q-600

QU \_98

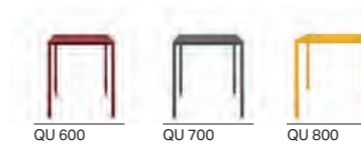

QU 600 QU 700 QU 800

VU \_104



VU B/T 1100 VU B/T 1300 VU B/Q 900 VU B/R 1600 VU B/R 2000 VU B/R 2400 VU A/R 1600 VU A/R 1600

Accesorios / Accessories \_118

Metal and aluminium colours / Couleurs du métal et de l'aluminium /

Colores metal y aluminio / Metall- und Aluminiumfarben \_120



# Daily 1

Jun Yasumoto, 2021

 MADE IN ITALY

CATAS



TECHNICAL DETAILS / DÉTAILS TECHNIQUES / DETALLES TECNICOS / TECHNISCHE DATEN

FRAME: TUBULAR METAL 18 MM / CHÂSSIS: TUBE D'ACIER 18 MM / ESTRUCTURA: TUBULAR EN METAL 18 MM / GESTELL: STAHLROHR 18 MM

SEAT AND BACK: PLYWOOD / ASSISE ET DOSSIER EN BOIS STRATIFIÉ / ASIENTO Y RESPALDO EN MADERA LAMINADA / SITZ UND RÜCKEN AUS SCHICHTHOLZ

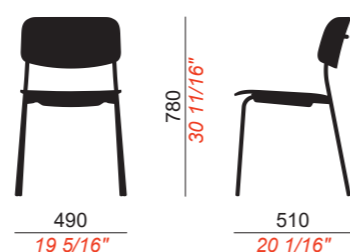

4 LEGS FRAME / CHÂSSIS À 4 PIEDS  
ESTRUCTURA 4 PATAS / GESTELL 4 BEINE

FINISHING FOR FRAME / FINITION CHÂSSIS  
ACABADOS ESTRUCTURA / SITZ UND RÜCKEN AUS SCHICHTHOLZ

WHITE VARNISHED  
VERNIS BLANC  
BARNIZADO BLANCO  
LACKIERT WEISS

NCS 0500 - N



BLACK VARNISHED  
VERNIS NOIR  
BARNIZADO NEGRO  
LACKIERT SCHWARZ

NCS 9000 - N



CHROMED  
CHROMÉ  
CROMADO  
VERCHROMED



ITEMS PER BOX QUANTITÉ PAR EMBALLAGE CANTIDADES POR CAJA ANZAHL PRO VERPACKUNG	PACKAGING SIZES DIMENSIONS EMBALLAGE DIMENSIONES EMBALAJE VERPACKUNG MASSE	PACKAGING VOLUME VOLUME EMBALLAGE VOLUMEN EMBALAJE VERPACKUNG VOLUMEN	BOX WEIGHT POIDS EMBALLAGE PESO CAJA VERPACKUNG GEWICHT
2	84x55x49	0,25	13

PLYWOOD BACK AND SEAT COLOURS / ASSISE ET DOSSIER EN BOIS STRATIFIÉ  
ASIENTO Y RESPALDO EN MADERA LAMINADA / SITZ UND RÜCKEN AUS SCHICHTHOLZ



Natural Oak  
Chêne Naturel  
Roble Natural  
Natürliche Eiche



Black Oak  
Chêne Noir  
Roble Negro  
Schwarze Eiche

# Daily 2

Jun Yasumoto, 2021

 MADE IN ITALY

CATAS



TECHNICAL DETAILS / DÉTAILS TECHNIQUES / DETALLES TECNICOS / TECHNISCHE DATEN

FRAME: TUBULAR METAL 18 MM / CHÂSSIS: TUBE D'ACIER 18 MM / ESTRUCTURA: TUBULAR EN METAL 18 MM / GESTELL: STAHLROHR 18 MM

SEAT AND BACK: PLYWOOD / ASSISE ET DOSSIER EN BOIS STRATIFIÉ / ASIENTO Y RESPALDO EN MADERA LAMINADA / SITZ UND RÜCKEN AUS SCHICHTHOLZ

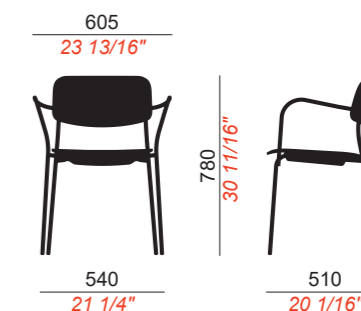
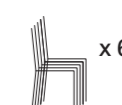

4 LEGS FRAME / CHÂSSIS À 4 PIEDS  
ESTRUCTURA 4 PATAS / GESTELL 4 BEINE

FINISHING FOR FRAME / FINITION CHÂSSIS  
ACABADOS ESTRUCTURA / SITZ UND RÜCKEN AUS SCHICHTHOLZ

WHITE VARNISHED  
VERNIS BLANC  
BARNIZADO BLANCO  
LACKIERT WEISS

NCS 0500 - N



BLACK VARNISHED  
VERNIS NOIR  
BARNIZADO NEGRO  
LACKIERT SCHWARZ

NCS 9000 - N



CHROMED  
CHROMÉ  
CROMADO  
VERCHROMED



ITEMS PER BOX QUANTITÉ PAR EMBALLAGE CANTIDADES POR CAJA ANZAHL PRO VERPACKUNG	PACKAGING SIZES DIMENSIONS EMBALLAGE DIMENSIONES EMBALAJE VERPACKUNG MASSE	PACKAGING VOLUME VOLUME EMBALLAGE VOLUMEN EMBALAJE VERPACKUNG VOLUMEN	BOX WEIGHT POIDS EMBALLAGE PESO CAJA VERPACKUNG GEWICHT
2	84x55x60	0,30	14

PLYWOOD BACK AND SEAT COLOURS / ASSISE ET DOSSIER EN BOIS STRATIFIÉ  
ASIENTO Y RESPALDO EN MADERA LAMINADA / SITZ UND RÜCKEN AUS SCHICHTHOLZ



Natural Oak  
Chêne Naturel  
Roble Natural  
Natürliche Eiche



Black Oak  
Chêne Noir  
Roble Negro  
Schwarze Eiche

Torre

Alban Le Henry, 2019



# Torre

Alban Le Henry, 2019

 MADE IN ITALY

CATAS



TECHNICAL DETAILS / DÉTAILS TECHNIQUES / DETALLES TECNICOS / TECHNISCHE DATEN

FRAME: POLYPROPYLENE / CHÂSSIS: POLYPROPYLÈNE  
ESTRUCTURA: POLIPROPILENO / GESTELL: POLYPROPYLEN

SHELL: POLYPROPYLENE / COQUE: POLYPROPYLÈNE  
CARCASA: POLIPROPILENO / SITZSCHALE: POLYPROPYLEN

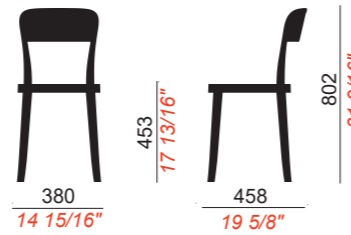

4 LEGS FRAME / CHÂSSIS À 4 PIEDS  
ESTRUCTURA 4 PATAS / GESTELL 4 BEINE

ITEMS PER BOX QUANTITÉ PAR EMBALLAGE CANTIDADES POR CAJA ANZAHL PRO VERPACKUNG	PACKAGING SIZES DIMENSIONS EMBALLAGE DIMENSIONES EMBALAJE VERPACKUNG MASSE	PACKAGING VOLUME VOLUME EMBALLAGE VOLUMEN EMBALAJE VERPACKUNG VOLUMEN	BOX WEIGHT POIDS EMBALLAGE PESO CAJA VERPACKUNG GEWICHT
4	51x51x97	0,25	15,5

PLASTIC COLOURS / COULEURS POLYPROPYLÈNE  
COLORES POLIPROPILENO / KUNSTOFF FARBE



BIANCO BLU GHIACCIO VERDE FORESTA FANGO MELANZANA GRIGIO SCURO NERO

NCS 0500 - N | NCS 1510 - R90B | NCS 5030 - G30Y | NCS 7010 - G90Y | NCS 5540 - Y90R | NCS 7500 - N | NCS 9000 - N

# Torre S

Alban Le Henry, 2019

 MADE IN ITALY

CATAS



TECHNICAL DETAILS / DÉTAILS TECHNIQUES / DETALLES TECNICOS / TECHNISCHE DATEN

FRAME: POLYPROPYLENE / CHÂSSIS: POLYPROPYLÈNE  
ESTRUCTURA: POLIPROPILENO / GESTELL: POLYPROPYLEN

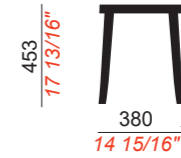

4 LEGS FRAME / CHÂSSIS À 4 PIEDS  
ESTRUCTURA 4 PATAS / GESTELL 4 BEINE

ITEMS PER BOX QUANTITÉ PAR EMBALLAGE CANTIDADES POR CAJA ANZAHL PRO VERPACKUNG	PACKAGING SIZES DIMENSIONS EMBALLAGE DIMENSIONES EMBALAJE VERPACKUNG MASSE	PACKAGING VOLUME VOLUME EMBALLAGE VOLUMEN EMBALAJE VERPACKUNG VOLUMEN	BOX WEIGHT POIDS EMBALLAGE PESO CAJA VERPACKUNG GEWICHT
4	51x51x62	0,16	12,5

PLASTIC COLOURS / COULEURS POLYPROPYLÈNE  
COLORES POLIPROPILENO / KUNSTOFF FARBE



BIANCO BLU GHIACCIO VERDE FORESTA FANGO MELANZANA GRIGIO SCURO NERO

NCS 0500 - N | NCS 1510 - R90B | NCS 5030 - G30Y | NCS 7010 - G90Y | NCS 5540 - Y90R | NCS 7500 - N | NCS 9000 - N

# Torre 103

Alban Le Henry, 2019

 MADE IN ITALY



TECHNICAL DETAILS / DÉTAILS TECHNIQUES / DETALLES TECNICOS / TECHNISCHE DATEN

PANEL IN POLYPROPYLENE PADDED AND UPHOLSTERED IN TEXTILE OR ECO LEATHER.  
COUSSIN EN POLYPROPYLÈNE REMBOURRÉ, TAPISSÉ EN TISSU OU EN FAUX CUIR

PANEL IN POLIPROPILENO ACOLCHADO Y TAPIZADO EN TELA O CUERO ARTIFICIAL  
SITZPLATTE AUS POLYPROPYLEN, GEPOLSTERT UND MIT STOFF ODER KUNSTLEDER BEZOGEN.

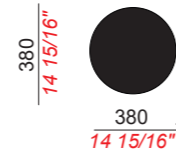

POLYPROPYLENE PADDED / POLYPROPYLÈNE REMBOURRÉ  
POLIPROPILENO ACOLCHADOS / POLYPROPYLEN GEPOLSTERT

PAD  
COUSSIN  
PANEL  
SITZ PLATTE





# Piazza

Jun Yasumoto, 2016/2019



# Piazza 1

Jun Yasumoto, 2016

 MADE IN ITALY

CATAS



TECHNICAL DETAILS / DÉTAILS TECHNIQUES / DETALLES TECNICOS / TECHNISCHE DATEN

MONOSHELL: POLYPROPYLENE / MONOCOQUE: POLYPROPYLÈNE  
MONOCASCO: POLIPROPILENO / MONOBLOCK SCHALE: POLYPROPYLEN

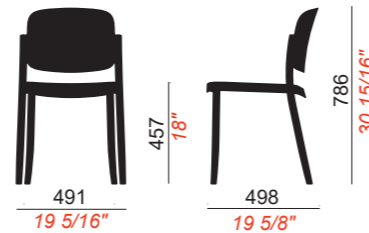
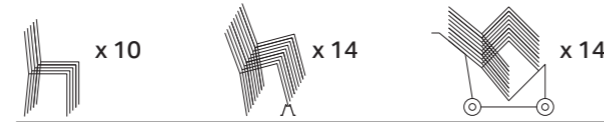

MONOSHELL 4 LEGS / MONOCOQUE À 4 PIEDS  
MONOCASCO 4 PATAS / MONOBLOCK SCHALE 4 BEINE

ITEMS PER BOX QUANTITÉ PAR EMBALLAGE CANTIDADES POR CAJA ANZAHL PRO VERPACKUNG	PACKAGING SIZES DIMENSIONS EMBALLAGE DIMENSIONES EMBALAJE VERPACKUNG MASSE	PACKAGING VOLUME VOLUME EMBALLAGE VOLUMEN EMBALAJE VERPACKUNG VOLUMEN	BOX WEIGHT POIDS EMBALLAGE PESO CAJA VERPACKUNG GEWICHT
4	67x50x96	0,32	19

 Colour Grigio Caldo Eco 100% recycled.  
Couleur Grigio Caldo Eco 100% recyclé.  
Color Grigio Caldo Eco 100% reciclado.  
Farbe Grigio Caldo Eco 100% recycelt.

PLASTIC COLOURS / COULEURS POLYPROPYLÈNE  
COLORES POLIPROPILENO / KUNSTOFF FARBE



BIANCO TORRENTE SABBIA MELANZANA VERDE SCURO GRIGIO CALDO NERO

NCS 0500 - N | NCS S 3005-G50Y | NCS 3010 - Y | NCS 5540 - Y90R | NCS 8010 - G10Y | NCS 6005 - Y20R | NCS 9000 - N

# Piazza 2

Jun Yasumoto, 2016

 MADE IN ITALY

CATAS



TECHNICAL DETAILS / DÉTAILS TECHNIQUES / DETALLES TECNICOS / TECHNISCHE DATEN

MONOSHELL: POLYPROPYLENE / MONOCOQUE: POLYPROPYLÈNE  
MONOCASCO: POLIPROPILENO / MONOBLOCK SCHALE: POLYPROPYLEN

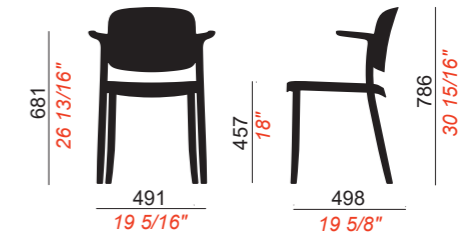
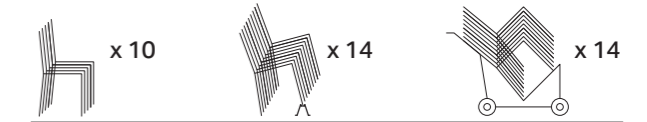

MONOSHELL 4 LEGS / MONOCOQUE À 4 PIEDS  
MONOCASCO 4 PATAS / MONOBLOCK SCHALE 4 BEINE

ITEMS PER BOX QUANTITÉ PAR EMBALLAGE CANTIDADES POR CAJA ANZAHL PRO VERPACKUNG	PACKAGING SIZES DIMENSIONS EMBALLAGE DIMENSIONES EMBALAJE VERPACKUNG MASSE	PACKAGING VOLUME VOLUME EMBALLAGE VOLUMEN EMBALAJE VERPACKUNG VOLUMEN	BOX WEIGHT POIDS EMBALLAGE PESO CAJA VERPACKUNG GEWICHT
4	67x56x96	0,36	21

 Colour Grigio Caldo Eco 100% recycled.  
Couleur Grigio Caldo Eco 100% recyclé.  
Color Grigio Caldo Eco 100% reciclado.  
Farbe Grigio Caldo Eco 100% recycelt.

PLASTIC COLOURS / COULEURS POLYPROPYLÈNE  
COLORES POLIPROPILENO / KUNSTOFF FARBE



BIANCO TORRENTE SABBIA MELANZANA VERDE SCURO GRIGIO CALDO NERO

NCS 0500 - N | NCS S 3005-G50Y | NCS 3010 - Y | NCS 5540 - Y90R | NCS 8010 - G10Y | NCS 6005 - Y20R | NCS 9000 - N

# Piazza 3A

Jun Yasumoto, 2019

 MADE IN ITALY

CATAS



TECHNICAL DETAILS / DÉTAILS TECHNIQUES / DETALLES TECNICOS / TECHNISCHE DATEN

FRAME: POLYPROPYLENE / CHÂSSIS: POLYPROPYLÈNE  
ESTRUCTURA: POLIPROPILENO / GESTELL: POLYPROPYLEN

SHELL: POLYPROPYLENE / COQUE: POLYPROPYLÈNE  
CARCASA: POLIPROPILENO / SITZSCHALE: POLYPROPYLEN

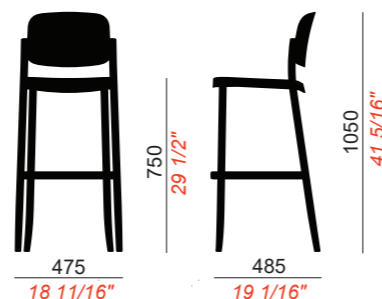

4 LEGS FRAME H:750 / CHÂSSIS À 4 PIEDS H:750  
ESTRUCTURA 4 PATAS H:750 / GESTELL 4 BEINE H:750

ITEMS PER BOX QUANTITÉ PAR EMBALLAGE CANTIDADES POR CAJA ANZAHL PRO VERPACKUNG	PACKAGING SIZES DIMENSIONS EMBALLAGE DIMENSIONES EMBALAJE VERPACKUNG MASSE	PACKAGING VOLUME VOLUME EMBALLAGE VOLUMEN EMBALAJE VERPACKUNG VOLUMEN	BOX WEIGHT POIDS EMBALLAGE PESO CAJA VERPACKUNG GEWICHT
2	53x46x113	0,28	14,0

 Colour Grigio Caldo Eco 100% recycled.  
Couleur Grigio Caldo Eco 100% recyclé.  
Color Grigio Caldo Eco 100% reciclado.  
Farbe Grigio Caldo Eco 100% recycelt.

PLASTIC COLOURS / COULEURS POLYPROPYLÈNE  
COLORES POLIPROPILENO / KUNSTOFF FARBE



BIANCO TORRENTE SABBIA MELANZANA VERDE SCURO GRIGIO CALDO NERO

NCS 0500 - N | NCS S 3005-G50Y | NCS 3010 - Y | NCS 5540 - Y90R | NCS 8010 - G10Y | NCS 6005 - Y20R | NCS 9000 - N

# Piazza 3B

Jun Yasumoto, 2019

 MADE IN ITALY

CATAS



TECHNICAL DETAILS / DÉTAILS TECHNIQUES / DETALLES TECNICOS / TECHNISCHE DATEN

FRAME: POLYPROPYLENE / CHÂSSIS: POLYPROPYLÈNE  
ESTRUCTURA: POLIPROPILENO / GESTELL: POLYPROPYLEN

SHELL: POLYPROPYLENE / COQUE: POLYPROPYLÈNE  
CARCASA: POLIPROPILENO / SITZSCHALE: POLYPROPYLEN

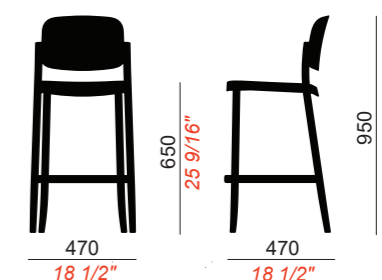

4 LEGS FRAME H:650 / CHÂSSIS À 4 PIEDS H:650  
ESTRUCTURA 4 PATAS H:650 / GESTELL 4 BEINE H:650

ITEMS PER BOX QUANTITÉ PAR EMBALLAGE CANTIDADES POR CAJA ANZAHL PRO VERPACKUNG	PACKAGING SIZES DIMENSIONS EMBALLAGE DIMENSIONES EMBALAJE VERPACKUNG MASSE	PACKAGING VOLUME VOLUME EMBALLAGE VOLUMEN EMBALAJE VERPACKUNG VOLUMEN	BOX WEIGHT POIDS EMBALLAGE PESO CAJA VERPACKUNG GEWICHT
2	53x46x103	0,25	13,5

 Colour Grigio Caldo Eco 100% recycled.  
Couleur Grigio Caldo Eco 100% recyclé.  
Color Grigio Caldo Eco 100% reciclado.  
Farbe Grigio Caldo Eco 100% recycelt.

PLASTIC COLOURS / COULEURS POLYPROPYLÈNE  
COLORES POLIPROPILENO / KUNSTOFF FARBE



BIANCO TORRENTE SABBIA MELANZANA VERDE SCURO GRIGIO CALDO NERO

NCS 0500 - N | NCS S 3005-G50Y | NCS 3010 - Y | NCS 5540 - Y90R | NCS 8010 - G10Y | NCS 6005 - Y20R | NCS 9000 - N

# Vesper

Christoph Jenni, 2014/2021



# Vesper 1

Christoph Jenni, 2014

MADE IN ITALY

CATAS



TECHNICAL DETAILS / DÉTAILS TECHNIQUES / DETALLES TECNICOS / TECHNISCHE DATEN

FRAME: TUBULAR METAL 20 MM / CHÂSSIS: TUBE D'ACIER 20 MM / ESTRUCTURA: TUBULAR EN METAL 20 MM / GESTELL: STAHLROHR 20 MM

SHELL: POLYPROPYLENE / COQUE: POLYPROPYLÈNE / CARCASA: POLIPROPILENO / SITZSCHALE: POLYPROPYLEN

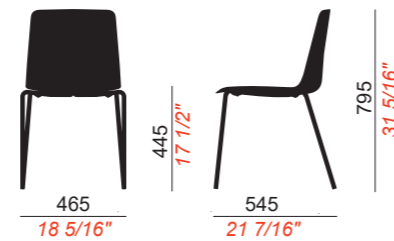
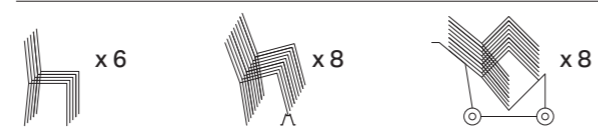

4 LEGS FRAME / CHÂSSIS À 4 PIEDS / ESTRUCTURA 4 PATAS / GESTELL 4 BEINE

FINISHING FOR FRAME / FINITION CHÂSSIS / ACABADOS ESTRUCTURA / SITZ UND RÜCKEN AUS SCHICHTHOLZ

WHITE VARNISHED  
VERNIS BLANC  
BARNIZADO BLANCO  
LACKIERT WEISS

NCS 0500 - N



BLACK VARNISHED  
VERNIS NOIR  
BARNIZADO NEGRO  
LACKIERT SCHWARZ

NCS 9000 - N



CHROMED  
CHROMÉ  
CROMADO  
VERCHROMED



ITEMS PER BOX  
QUANTITÉ PAR EMBALLAGE  
CANTIDADES POR CAJA  
ANZAHL PRO VERPACKUNG

4

PACKAGING SIZES  
DIMENSIONS EMBALLAGE  
DIMENSIONES EMBALAJE  
VERPACKUNG MASSE

67x50x96

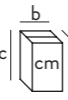

PACKAGING VOLUME  
VOLUME EMBALLAGE  
VOLUMEN EMBALAJE  
VERPACKUNG VOLUMEN

0,32



BOX WEIGHT  
POIDS EMBALLAGE  
PESO CAJA  
VERPACKUNG GEWICHT

19



PLASTIC COLOURS / COULEURS POLYPROPYLÈNE / COLORES POLIPROPILENO / KUNSTOFF FARBE

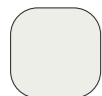

BIANCO

NCS 0500 - N



CELESTE

NCS 1010 - B



SABBIA

NCS 3010 - Y



VERDE FORESTA

NCS 5030 - G30Y



ROSSO

NCS 1085 - Y90R



GRIGIO

NCS 5500 - N



NERO

NCS 9000 - N

# Vesper 2

Christoph Jenni, 2014

MADE IN ITALY

CATAS



TECHNICAL DETAILS / DÉTAILS TECHNIQUES / DETALLES TECNICOS / TECHNISCHE DATEN

FRAME: TUBULAR METAL 20 MM / CHÂSSIS: TUBE D'ACIER 20 MM / ESTRUCTURA: TUBULAR EN METAL 20 MM / GESTELL: STAHLROHR 20 MM

SHELL: POLYPROPYLENE / COQUE: POLYPROPYLÈNE / CARCASA: POLIPROPILENO / SITZSCHALE: POLYPROPYLEN

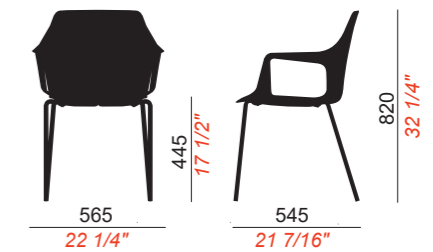
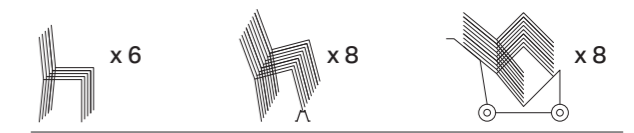

4 LEGS FRAME / CHÂSSIS À 4 PIEDS / ESTRUCTURA 4 PATAS / GESTELL 4 BEINE

FINISHING FOR FRAME / FINITION CHÂSSIS / ACABADOS ESTRUCTURA / SITZ UND RÜCKEN AUS SCHICHTHOLZ

WHITE VARNISHED  
VERNIS BLANC  
BARNIZADO BLANCO  
LACKIERT WEISS

NCS 0500 - N



BLACK VARNISHED  
VERNIS NOIR  
BARNIZADO NEGRO  
LACKIERT SCHWARZ

NCS 9000 - N



CHROMED  
CHROMÉ  
CROMADO  
VERCHROMED



ITEMS PER BOX  
QUANTITÉ PAR EMBALLAGE  
CANTIDADES POR CAJA  
ANZAHL PRO VERPACKUNG

4

PACKAGING SIZES  
DIMENSIONS EMBALLAGE  
DIMENSIONES EMBALAJE  
VERPACKUNG MASSE

67x56x96

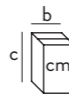

PACKAGING VOLUME  
VOLUME EMBALLAGE  
VOLUMEN EMBALAJE  
VERPACKUNG VOLUMEN

0,36



BOX WEIGHT  
POIDS EMBALLAGE  
PESO CAJA  
VERPACKUNG GEWICHT

22

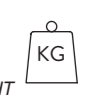

PLASTIC COLOURS / COULEURS POLYPROPYLÈNE / COLORES POLIPROPILENO / KUNSTOFF FARBE



BIANCO

NCS 0500 - N



CELESTE

NCS 1010 - B



SABBIA

NCS 3010 - Y



VERDE FORESTA

NCS 5030 - G30Y



ROSSO

NCS 1085 - Y90R



GRIGIO

NCS 5500 - N



NERO

NCS 9000 - N

# Vesper 1SW

Christoph Jenni, 2014

 MADE IN ITALY



**TECHNICAL DETAILS / DÉTAILS TECHNIQUES / DETALLES TECNICOS / TECHNISCHE DATEN**

**BASE: ALUMINUM / BASE: ALUMINIUM / BASE: ALUMINIO / GESTELL: ALLUMINIUM**

**SHELL: POLYPROPYLENE / COQUE: POLYPROPYLÈNE / CARCASA: POLIPROPILENO / SITZSCHALE: POLYPROPYLEN**



**SWIVEL BASE / BASE GIRATOIRE / BASE GIRATORIA / DREHBARES GESTELL**

**FINISHING FOR FRAME / FINITION CHÂSSIS / ACABADOS ESTRUCTURA / SITZ UND RÜCKEN AUS SCHICHTHOLZ**

**POLISHED / POLI / LUCIDO / POLIERT**



ITEMS PER BOX QUANTITÉ PAR EMBALLAGE CANTIDADES POR CAJA ANZAHL PRO VERPACKUNG	PACKAGING SIZES DIMENSIONS EMBALLAGE DIMENSIONES EMBALAJE VERPACKUNG MASSE	PACKAGING VOLUME VOLUME EMBALLAGE VOLUMEN EMBALAJE VERPACKUNG VOLUMEN	BOX WEIGHT POIDS EMBALLAGE PESO CAJA VERPACKUNG GEWICHT
2	67x56x96	0,36	20

**PLASTIC COLOURS / COULEURS POLYPROPYLÈNE / COLORES POLIPROPILENO / KUNSTOFF FARBE**



BIANCO CELESTE SABBIA VERDE FORESTA ROSSO GRIGIO NERO

NCS 0500 - N	NCS 1010 - B	NCS 3010 - Y	NCS 5030 - G30Y	NCS 1085 - Y90R	NCS 5500 - N	NCS 9000 - N
--------------	--------------	--------------	-----------------	-----------------	--------------	--------------

# Vesper 2SW

Christoph Jenni, 2014

 MADE IN ITALY



**TECHNICAL DETAILS / DÉTAILS TECHNIQUES / DETALLES TECNICOS / TECHNISCHE DATEN**

**BASE: ALUMINUM / BASE: ALUMINIUM / BASE: ALUMINIO / GESTELL: ALLUMINIUM**

**SHELL: POLYPROPYLENE / COQUE: POLYPROPYLÈNE / CARCASA: POLIPROPILENO / SITZSCHALE: POLYPROPYLEN**

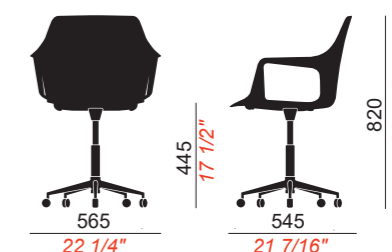

**SWIVEL BASE / BASE GIRATOIRE / BASE GIRATORIA / DREHBARES GESTELL**

**FINISHING FOR FRAME / FINITION CHÂSSIS / ACABADOS ESTRUCTURA / SITZ UND RÜCKEN AUS SCHICHTHOLZ**

**POLISHED / POLI / LUCIDO / POLIERT**



ITEMS PER BOX QUANTITÉ PAR EMBALLAGE CANTIDADES POR CAJA ANZAHL PRO VERPACKUNG	PACKAGING SIZES DIMENSIONS EMBALLAGE DIMENSIONES EMBALAJE VERPACKUNG MASSE	PACKAGING VOLUME VOLUME EMBALLAGE VOLUMEN EMBALAJE VERPACKUNG VOLUMEN	BOX WEIGHT POIDS EMBALLAGE PESO CAJA VERPACKUNG GEWICHT
2	67x56x96	0,36	22

**PLASTIC COLOURS / COULEURS POLYPROPYLÈNE / COLORES POLIPROPILENO / KUNSTOFF FARBE**



BIANCO CELESTE SABBIA VERDE FORESTA ROSSO GRIGIO NERO

NCS 0500 - N	NCS 1010 - B	NCS 3010 - Y	NCS 5030 - G30Y	NCS 1085 - Y90R	NCS 5500 - N	NCS 9000 - N
--------------	--------------	--------------	-----------------	-----------------	--------------	--------------

# Vesper 3A

Christoph Jenni, 2014

 MADE IN ITALY



TECHNICAL DETAILS / DÉTAILS TECHNIQUES / DETALLES TECNICOS / TECHNISCHE DATEN

FRAME: STEEL 12 MM / CHÂSSIS: ACIER 12 MM / ESTRUCTURA: ACERO 12 MM / GESTELL: STAHLROHR 12 MM

SHELL: POLYPROPYLENE / COQUE: POLYPROPYLÈNE / CARCASA: POLIPROPILENO / SITZSCHALE: POLYPROPYLEN

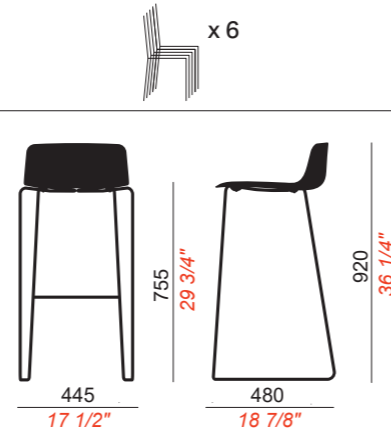

STEEL FRAME H:750 / CHÂSSIS ACIER H:750 / ESTRUCTURA EN ACERO H:750 / STAHL GESTELL H:750

FINISHING FOR FRAME / FINITION CHÂSSIS / ACABADOS ESTRUCTURA / SITZ UND RÜCKEN AUS SCHICHTHOLZ

WHITE VARNISHED  
VERNIS BLANC  
BARNIZADO BLANCO  
LACKIERT WEISS

NCS 0500 - N



BLACK VARNISHED  
VERNIS NOIR  
BARNIZADO NEGRO  
LACKIERT SCHWARZ

NCS 9000 - N



CHROMED  
CHROMÉ  
CROMADO  
VERCHROMED



ITEMS PER BOX  
QUANTITÉ PAR EMBALLAGE  
CANTIDADES POR CAJA  
ANZAHL PRO VERPACKUNG

2

PACKAGING SIZES  
DIMENSIONS EMBALLAGE  
DIMENSIONES EMBALAJE  
VERPACKUNG MASSE

67x50x96

PACKAGING VOLUME  
VOLUME EMBALLAGE  
VOLUMEN EMBALAJE  
VERPACKUNG VOLUMEN

0,32

BOX WEIGHT  
POIDS EMBALLAGE  
PESO CAJA  
VERPACKUNG GEWICHT

15

PLASTIC COLOURS / COULEURS POLYPROPYLÈNE / COLORES POLIPROPILENO / KUNSTOFF FARBE



BIANCO



CELESTE



SABBIA



VERDE FORESTA



ROSSO



GRIGIO



NERO

NCS 0500 - N | NCS 1010 - B | NCS 3010 - Y | NCS 5030 - G30Y | NCS 1085 - Y90R | NCS 5500 - N | NCS 9000 - N

# Vesper 3B

Christoph Jenni, 2014

 MADE IN ITALY



TECHNICAL DETAILS / DÉTAILS TECHNIQUES / DETALLES TECNICOS / TECHNISCHE DATEN

FRAME: STEEL 12 MM / CHÂSSIS: ACIER 12 MM / ESTRUCTURA: ACERO 12 MM / GESTELL: STAHLROHR 12 MM

SHELL: POLYPROPYLENE / COQUE: POLYPROPYLÈNE / CARCASA: POLIPROPILENO / SITZSCHALE: POLYPROPYLEN

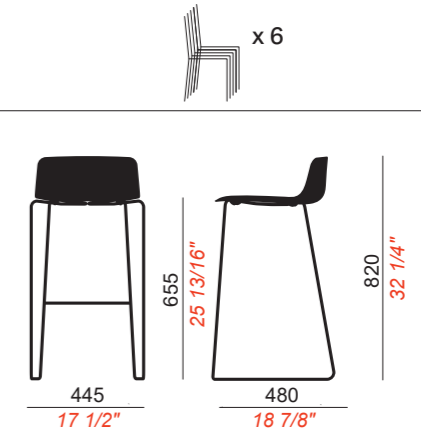

STEEL FRAME H:650 / CHÂSSIS ACIER H:650 / ESTRUCTURA EN ACERO H:650 / STAHL GESTELL H:650

FINISHING FOR FRAME / FINITION CHÂSSIS / ACABADOS ESTRUCTURA / SITZ UND RÜCKEN AUS SCHICHTHOLZ

WHITE VARNISHED  
VERNIS BLANC  
BARNIZADO BLANCO  
LACKIERT WEISS

NCS 0500 - N



BLACK VARNISHED  
VERNIS NOIR  
BARNIZADO NEGRO  
LACKIERT SCHWARZ

NCS 9000 - N



CHROMED  
CHROMÉ  
CROMADO  
VERCHROMED



ITEMS PER BOX  
QUANTITÉ PAR EMBALLAGE  
CANTIDADES POR CAJA  
ANZAHL PRO VERPACKUNG

2

PACKAGING SIZES  
DIMENSIONS EMBALLAGE  
DIMENSIONES EMBALAJE  
VERPACKUNG MASSE

67x50x96

PACKAGING VOLUME  
VOLUME EMBALLAGE  
VOLUMEN EMBALAJE  
VERPACKUNG VOLUMEN

0,32

BOX WEIGHT  
POIDS EMBALLAGE  
PESO CAJA  
VERPACKUNG GEWICHT

15

PLASTIC COLOURS / COULEURS POLYPROPYLÈNE / COLORES POLIPROPILENO / KUNSTOFF FARBE



BIANCO



CELESTE



SABBIA



VERDE FORESTA



ROSSO



GRIGIO



NERO

NCS 0500 - N | NCS 1010 - B | NCS 3010 - Y | NCS 5030 - G30Y | NCS 1085 - Y90R | NCS 5500 - N | NCS 9000 - N

# Vesper GP02

Christoph Jenni, 2014

 MADE IN ITALY



TECHNICAL DETAILS / DÉTAILS TECHNIQUES / DETALLES  
TECNICOS / TECHNISCHE DATEN

FRAME: METAL BEAM 80X40MM WITH ALUMINIUM LEG GP02  
/ CHÂSSIS: POUTRE 80X40MM AVEC PIED ALUMINIUM GP02 /  
ESTRUCTURA: VIGA 80X40MM CON PATA DE ALUMINIO GP02 /  
GESTELL: BAR AUS STAHL 80X40 MM UND BEINE AUS ALUMINIUM

SHELL: POLYPROPYLENE / COQUE: POLYPROPYLÈNE  
CARCASA: POLIPROPILENO / SITZSCHALE: POLYPROPYLEN



4 LEGS FRAME / CHÂSSIS À 4 PIEDS  
ESTRUCTURA 4 PATAS / GESTELL 4 BEINE

MODEL / MODÈLE  
MODELO / MODELL

2 SEATS / 2 PLACES  
2 ASIENTOS / 2 SITZIG

3 SEATS / 3 PLACES  
3 ASIENTOS / 3 SITZIG

4 SEATS / 4 PLACES  
4 ASIENTOS / 4 SITZIG

5 SEATS / 5 PLACES  
5 ASIENTOS / 5 SITZIG

FRAME COLOUR / COULEURS CHÂSSIS  
COLORES ESTRUCTURA / FARBE BAR

BLACK / NOIR  
NEGRO / SCHWARZ



LEG COLOUR / COULEURS PIED  
COLORES PATA / FARBE BEINE

GREY PAINTED ALUMINIUM  
VERNI GRIS  
BARNIZADO GRIS  
ALUMINIUM GEFÄRBT GRAU



ALUMINIUM / POLI  
LUCIDO / POLIERT



PLASTIC COLOURS / COULEURS POLYPROPYLÈNE  
COLORES POLIPROPILENO / KUNSTOFF FARBE



BIANCO



CELESTE



SABBIA



VERDE FORESTA



ROSSO



GRIGIO



NERO

NCS 0500 - N

NCS 1010 - B

NCS 3010 - Y

NCS 5030 - G30Y

NCS 1085 - Y90R

NCS 5500 - N

NCS 9000 - N

# Vesper GP04

Christoph Jenni, 2014

 MADE IN ITALY



TECHNICAL DETAILS / DÉTAILS TECHNIQUES / DETALLES  
TECNICOS / TECHNISCHE DATEN

FRAME: METAL BEAM 80X40MM WITH NYLON LEG GP04  
/ CHÂSSIS: POUTRE 80X40MM AVEC PIED NYLON GP04 /  
ESTRUCTURA: VIGA 40X80MM CON PATA DE NYLON GP04 /  
GESTELL: BAR AUS STAHL 80X40 MM UND BEINE AUS NYLON  
GP04

SHELL: POLYPROPYLENE / COQUE: POLYPROPYLÈNE  
CARCASA: POLIPROPILENO / SITZSCHALE: POLYPROPYLEN



4 LEGS FRAME / CHÂSSIS À 4 PIEDS  
ESTRUCTURA 4 PATAS / GESTELL 4 BEINE

MODEL / MODÈLE  
MODELO / MODELL

2 SEATS / 2 PLACES  
2 ASIENTOS / 2 SITZIG

3 SEATS / 3 PLACES  
3 ASIENTOS / 3 SITZIG

4 SEATS / 4 PLACES  
4 ASIENTOS / 4 SITZIG

5 SEATS / 5 PLACES  
5 ASIENTOS / 5 SITZIG

FRAME COLOUR / COULEURS CHÂSSIS  
COLORES ESTRUCTURA / FARBE BAR

BLACK / NOIR  
NEGRO / SCHWARZ



LEG COLOUR / COULEURS PIED  
COLORES PATA / FARBE BEINE

BLACK / NOIR  
NEGRO / SCHWARZ



PLASTIC COLOURS / COULEURS POLYPROPYLÈNE  
COLORES POLIPROPILENO / KUNSTOFF FARBE



BIANCO



CELESTE



SABBIA



VERDE FORESTA



ROSSO



GRIGIO



NERO

NCS 0500 - N

NCS 1010 - B

NCS 3010 - Y

NCS 5030 - G30Y

NCS 1085 - Y90R

NCS 5500 - N

NCS 9000 - N



# Vesper 103

Christoph Jenni, 2014

 MADE IN ITALY



TECHNICAL DETAILS / DÉTAILS TECHNIQUES / DETALLES TECNICOS / TECHNISCHE DATEN

PANEL IN POLYPROPYLENE PADDED AND UPHOLSTERED IN TEXTILE OR ECO LEATHER.  
COUSSIN EN POLYPROPYLÈNE REMBOURRÉ, TAPISSÉ EN TISSU OU EN FAUX CUIR

PANEL IN POLIPROPILENO ACOLCHADO Y TAPIZADO EN TELA O CUERO ARTIFICIAL  
SITZPLATTE AUS POLYPROPYLEN, GEPOLSTERT UND MIT STOFF ODER KUNSTLEDER BEZOGEN.

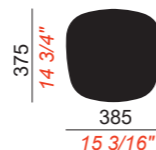

POLYPROPYLENE PADDED / POLYPROPYLÈNE REMBOURRÉ  
POLIPROPILENO ACOLCHADOS / POLYPROPYLEN GEPOLSTERT

PAD  
COUSSIN  
PANEL  
SITZ PLATTE





# Split

Francesco Meda, 2016

 MADE IN ITALY

CATAS



TECHNICAL DETAILS / DÉTAILS TECHNIQUES / DETALLES TECNICOS / TECHNISCHE DATEN

FRAME: POLYPROPYLENE / CHÂSSIS: POLYPROPYLÈNE  
ESTRUCTURA: POLIPROPILENO / GESTELL: POLYPROPYLEN

SHELL: POLYPROPYLENE / COQUE: POLYPROPYLÈNE  
CARCASA: POLIPROPILENO / SITZSCHALE: POLYPROPYLEN

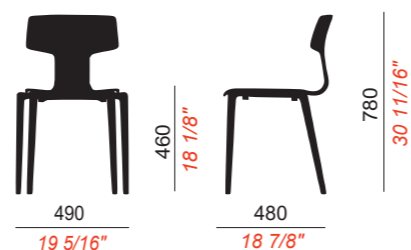
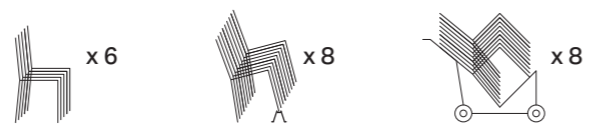

4 LEGS FRAME / CHÂSSIS À 4 PIEDS  
ESTRUCTURA 4 PATAS / GESTELL 4 BEINE

ITEMS PER BOX QUANTITÉ PAR EMBALLAGE CANTIDADES POR CAJA ANZAHL PRO VERPACKUNG	PACKAGING SIZES DIMENSIONS EMBALLAGE DIMENSIONES EMBALAJE VERPACKUNG MASSE	PACKAGING VOLUME VOLUME EMBALLAGE VOLUMEN EMBALAJE VERPACKUNG VOLUMEN	BOX WEIGHT POIDS EMBALLAGE PESO CAJA VERPACKUNG GEWICHT
4	67x50x96	0,32	20

 Colour Grigio Caldo Eco 100% recycled.  
Couleur Grigio Caldo Eco 100% recyclé.  
Color Grigio Caldo Eco 100% reciclado.  
Farbe Grigio Caldo Eco 100% recycelt.

PLASTIC COLOURS / COULEURS POLYPROPYLÈNE  
COLORES POLIPROPILENO / KUNSTOFF FARBE



BIANCO    SABBIA    ROSSO    MELANZANA    VERDE SCURO    GRIGIO CALDO ECO    NERO

NCS 0500 - N    NCS 3010 - Y    NCS 1085 - Y90R    NCS 5540-Y90R    NCS 8010 - G10Y    NCS 6005 - Y20R    NCS 9000 - N

# Split GL

Francesco Meda, 2017

 MADE IN ITALY

CATAS



TECHNICAL DETAILS / DÉTAILS TECHNIQUES / DETALLES TECNICOS / TECHNISCHE DATEN

FRAME: WOOD / CHÂSSIS: BOIS  
ESTRUCTURA: MADERA / GESTELL: HOLZ

SHELL: POLYPROPYLENE / COQUE: POLYPROPYLÈNE  
CARCASA: POLIPROPILENO / SITZSCHALE: POLYPROPYLEN

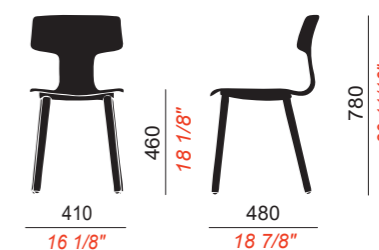

4 LEGS FRAME / CHÂSSIS À 4 PIEDS  
ESTRUCTURA 4 PATAS / GESTELL 4 BEINE

ITEMS PER BOX QUANTITÉ PAR EMBALLAGE CANTIDADES POR CAJA ANZAHL PRO VERPACKUNG	PACKAGING SIZES DIMENSIONS EMBALLAGE DIMENSIONES EMBALAJE VERPACKUNG MASSE	PACKAGING VOLUME VOLUME EMBALLAGE VOLUMEN EMBALAJE VERPACKUNG VOLUMEN	BOX WEIGHT POIDS EMBALLAGE PESO CAJA VERPACKUNG GEWICHT
2	67x50x96	0,32	12

WOODEN BASE COLOUR / COULEURS CHÂSSIS EN BOIS  
COLORES BASE IN MADERA / GESTELL HOLZ FARBE



OAK / CHÈNE  
ROBLE / EICHENHOLZ

 Colour Grigio Caldo Eco 100% recycled.  
Couleur Grigio Caldo Eco 100% recyclé.  
Color Grigio Caldo Eco 100% reciclado.  
Farbe Grigio Caldo Eco 100% recycelt.

PLASTIC COLOURS / COULEURS POLYPROPYLÈNE  
COLORES POLIPROPILENO / KUNSTOFF FARBE



BIANCO    SABBIA    ROSSO    MELANZANA    VERDE SCURO    GRIGIO CALDO ECO    NERO

NCS 0500 - N    NCS 3010 - Y    NCS 1085 - Y90R    NCS 5540-Y90R    NCS 8010 - G10Y    NCS 6005 - Y20R    NCS 9000 - N

# Split 1

Francesco Meda, 2018

 MADE IN ITALY

CATAS



TECHNICAL DETAILS / DÉTAILS TECHNIQUES / DETALLES TECNICOS / TECHNISCHE DATEN

FRAME: TUBULAR METAL 18 MM / CHÂSSIS: TUBE D'ACIER 18 MM / ESTRUCTURA: TUBULAR EN METAL 18 MM / GESTELL: STAHLROHR 18 MM

SHELL: POLYPROPYLENE / COQUE: POLYPROPYLÈNE / CARCASA: POLIPROPILENO / SITZSCHALE: POLYPROPYLEN

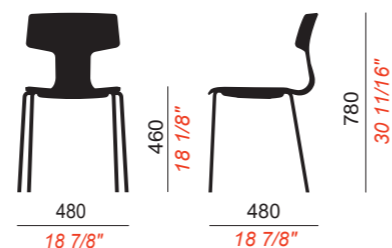
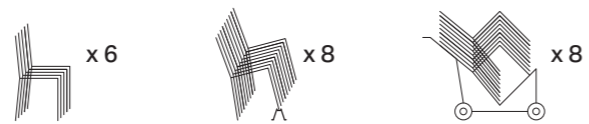

4 LEGS FRAME / CHÂSSIS À 4 PIEDS / ESTRUCTURA 4 PATAS / GESTELL 4 BEINE

FINISHING FOR FRAME / FINITION CHÂSSIS / ACABADOS ESTRUCTURA / SITZ UND RÜCKEN AUS SCHICHTHOLZ

BLACK / WHITE VARNISHED  
VERNIS BLANC / NOIR  
BARNIZADO BLANCO / NEGRO  
LACKIERT WEISS / SCHWARZ



COLOURS VARNISHED  
VERNIS COULEURS  
BARNIZADO COLORES  
FARBE LACKIERT



CHROMED  
CHROMÉ  
CROMADO  
VERCHROMT



ITEMS PER BOX  
QUANTITÉ PAR EMBALLAGE  
CANTIDADES POR CAJA  
ANZAHL PRO VERPACKUNG

PACKAGING SIZES  
DIMENSIONS EMBALLAGE  
DIMENSIONES EMBALAJE  
VERPACKUNG MASSE



PACKAGING VOLUME  
VOLUME EMBALLAGE  
VOLUMEN EMBALAJE  
VERPACKUNG VOLUMEN



BOX WEIGHT  
POIDS EMBALLAGE  
PESO CAJA  
VERPACKUNG GEWICHT



4

67x50x96

0,32

20

 Colour Grigio Caldo Eco 100% recycled.  
Couleur Grigio Caldo Eco 100% recyclé.  
Color Grigio Caldo Eco 100% reciclado.  
Farbe Grigio Caldo Eco 100% recycelt.

PLASTIC COLOURS / COULEURS POLYPROPYLÈNE  
COLORES POLIPROPILENO / KUNSTOFF FARBE



BIANCO    SABBIA    ROSSO    MELANZANA    VERDE SCURO    GRIGIO CALDO ECO    NERO

NCS 0500 - N    NCS 3010 - Y    NCS 1085 - Y90R    NCS 5540-Y90R    NCS 8010 - G10Y    NCS 6005 - Y20R    NCS 9000 - N

# Split Kids

Francesco Meda, 2018

 MADE IN ITALY

CATAS



TECHNICAL DETAILS / DÉTAILS TECHNIQUES / DETALLES TECNICOS / TECHNISCHE DATEN

FRAME: TUBULAR METAL 14 MM / CHÂSSIS: TUBE D'ACIER 14 MM / ESTRUCTURA: TUBULAR EN METAL 14 MM / GESTELL: STAHLROHR 14 MM

SHELL: POLYPROPYLENE / COQUE: POLYPROPYLÈNE / CARCASA: POLIPROPILENO / SITZSCHALE: POLYPROPYLEN

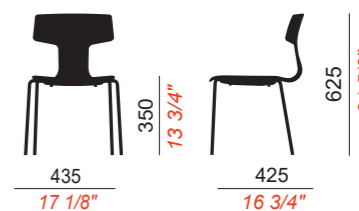
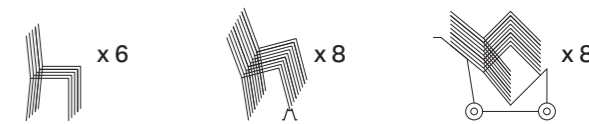

4 LEGS FRAME / CHÂSSIS À 4 PIEDS / ESTRUCTURA 4 PATAS / GESTELL 4 BEINE

FINISHING FOR FRAME / FINITION CHÂSSIS / ACABADOS ESTRUCTURA / SITZ UND RÜCKEN AUS SCHICHTHOLZ

BLACK / WHITE VARNISHED  
VERNIS BLANC / NOIR  
BARNIZADO BLANCO / NEGRO  
LACKIERT WEISS / SCHWARZ



COLOURS VARNISHED  
VERNIS COULEURS  
BARNIZADO COLORES  
FARBE LACKIERT



CHROMED  
CHROMÉ  
CROMADO  
VERCHROMT



ITEMS PER BOX  
QUANTITÉ PAR EMBALLAGE  
CANTIDADES POR CAJA  
ANZAHL PRO VERPACKUNG

PACKAGING SIZES  
DIMENSIONS EMBALLAGE  
DIMENSIONES EMBALAJE  
VERPACKUNG MASSE



PACKAGING VOLUME  
VOLUME EMBALLAGE  
VOLUMEN EMBALAJE  
VERPACKUNG VOLUMEN



BOX WEIGHT  
POIDS EMBALLAGE  
PESO CAJA  
VERPACKUNG GEWICHT



4

42x53x75

0,17

14

 Colour Grigio Caldo Eco 100% recycled.  
Couleur Grigio Caldo Eco 100% recyclé.  
Color Grigio Caldo Eco 100% reciclado.  
Farbe Grigio Caldo Eco 100% recycelt.

PLASTIC COLOURS / COULEURS POLYPROPYLÈNE  
COLORES POLIPROPILENO / KUNSTOFF FARBE



BIANCO    SABBIA    ROSSO    MELANZANA    VERDE SCURO    GRIGIO CALDO ECO    NERO

NCS 0500 - N    NCS 3010 - Y    NCS 1085 - Y90R    NCS 5540-Y90R    NCS 8010 - G10Y    NCS 6005 - Y20R    NCS 9000 - N

# Split 3A

Francesco Meda, 2018

 MADE IN ITALY



**TECHNICAL DETAILS / DÉTAILS TECHNIQUES / DETALLES TECNICOS / TECHNISCHE DATEN**

**FRAME: TUBULAR METAL 14 MM / CHÂSSIS: TUBE D'ACIER 14 MM / ESTRUCTURA: TUBULAR EN METAL 14 MM / GESTELL: STAHLROHR 14 MM**

**SHELL: POLYPROPYLENE / COQUE: POLYPROPYLÈNE / CARCASA: POLIPROPILENO / SITZSCHALE: POLYPROPYLEN**

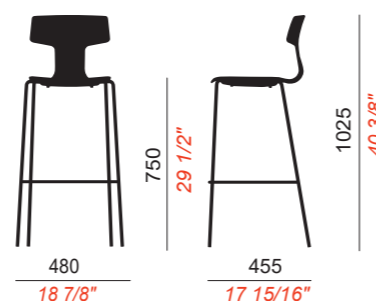

**4 LEGS FRAME H:750 / CHÂSSIS À 4 PIEDS H:750 / ESTRUCTURA 4 PATAS H:750 / GESTELL 4 BEINE H:750**

**FINISHING FOR FRAME / FINITION CHÂSSIS / ACABADOS ESTRUCTURA / SITZ UND RÜCKEN AUS SCHICHTHOLZ**

**BLACK / WHITE VARNISHED / VERNIS BLANC / NOIR / BARNIZADO BLANCO / NEGRO / LACKIERT WEISS / SCHWARZ**



**COLOURS VARNISHED / VERNIS COULEURS / BARNIZADO COLORES / FARBE LACKIERT**



**CHROMED / CHROMÉ / CROMADO / VERCHROMT**



ITEMS PER BOX QUANTITÉ PAR EMBALLAGE CANTIDADES POR CAJA ANZAHL PRO VERPACKUNG	PACKAGING SIZES DIMENSIONS EMBALLAGE DIMENSIONES EMBALAJE VERPACKUNG MASSE	PACKAGING VOLUME VOLUME EMBALLAGE VOLUMEN EMBALAJE VERPACKUNG VOLUMEN	BOX WEIGHT POIDS EMBALLAGE PESO CAJA VERPACKUNG GEWICHT
2	48x48x110	0,25	13

 **Colour Grigio Caldo Eco 100% recycled. / Couleur Grigio Caldo Eco 100% recyclé. / Color Grigio Caldo Eco 100% reciclado. / Farbe Grigio Caldo Eco 100% recycelt.**

**PLASTIC COLOURS / COULEURS POLYPROPYLÈNE / COLORES POLIPROPILENO / KUNSTOFF FARBE**



BIANCO    SABBIA    ROSSO    MELANZANA    VERDE SCURO    GRIGIO CALDO ECO    NERO

NCS 0500 - N    NCS 3010 - Y    NCS 1085 - Y90R    NCS 5540-Y90R    NCS 8010 - G10Y    NCS 6005 - Y20R    NCS 9000 - N

# Split 3B

Francesco Meda, 2018

 MADE IN ITALY



**TECHNICAL DETAILS / DÉTAILS TECHNIQUES / DETALLES TECNICOS / TECHNISCHE DATEN**

**FRAME: TUBULAR METAL 14 MM / CHÂSSIS: TUBE D'ACIER 14 MM / ESTRUCTURA: TUBULAR EN METAL 14 MM / GESTELL: STAHLROHR 14 MM**

**SHELL: POLYPROPYLENE / COQUE: POLYPROPYLÈNE / CARCASA: POLIPROPILENO / SITZSCHALE: POLYPROPYLEN**

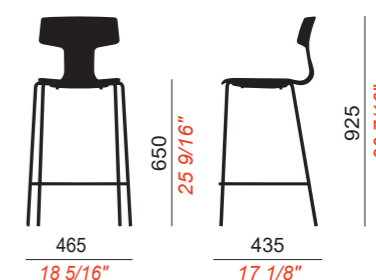
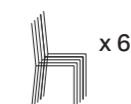

**4 LEGS FRAME H:650 / CHÂSSIS À 4 PIEDS H:650 / ESTRUCTURA 4 PATAS H:650 / GESTELL 4 BEINE H:650**

**FINISHING FOR FRAME / FINITION CHÂSSIS / ACABADOS ESTRUCTURA / SITZ UND RÜCKEN AUS SCHICHTHOLZ**

**BLACK / WHITE VARNISHED / VERNIS BLANC / NOIR / BARNIZADO BLANCO / NEGRO / LACKIERT WEISS / SCHWARZ**



**COLOURS VARNISHED / VERNIS COULEURS / BARNIZADO COLORES / FARBE LACKIERT**



**CHROMED / CHROMÉ / CROMADO / VERCHROMT**



ITEMS PER BOX QUANTITÉ PAR EMBALLAGE CANTIDADES POR CAJA ANZAHL PRO VERPACKUNG	PACKAGING SIZES DIMENSIONS EMBALLAGE DIMENSIONES EMBALAJE VERPACKUNG MASSE	PACKAGING VOLUME VOLUME EMBALLAGE VOLUMEN EMBALAJE VERPACKUNG VOLUMEN	BOX WEIGHT POIDS EMBALLAGE PESO CAJA VERPACKUNG GEWICHT
2	48x48x97	0,22	12,5

 **Colour Grigio Caldo Eco 100% recycled. / Couleur Grigio Caldo Eco 100% recyclé. / Color Grigio Caldo Eco 100% reciclado. / Farbe Grigio Caldo Eco 100% recycelt.**

**PLASTIC COLOURS / COULEURS POLYPROPYLÈNE / COLORES POLIPROPILENO / KUNSTOFF FARBE**



BIANCO    SABBIA    ROSSO    MELANZANA    VERDE SCURO    GRIGIO CALDO ECO    NERO

NCS 0500 - N    NCS 3010 - Y    NCS 1085 - Y90R    NCS 5540-Y90R    NCS 8010 - G10Y    NCS 6005 - Y20R    NCS 9000 - N

# Split 103

Francesco Meda, 2020

 MADE IN ITALY



**TECHNICAL DETAILS / DÉTAILS TECHNIQUES / DETALLES TECNICOS / TECHNISCHE DATEN**

**PANEL IN POLYPROPYLENE PADDED AND UPHOLSTERED IN TEXTILE OR ECO LEATHER.**

**COUSSIN EN POLYPROPYLÈNE REMBOURRÉ, TAPISSÉ EN TISSU OU EN FAUX CUIR**

**PANEL IN POLIPROPILENO ACOLCHADO Y TAPIZADO EN TELA O CUERO ARTIFICIAL**

**SITZPLATTE AUS POLYPROPYLEN, GEPOLSTERT UND MIT STOFF ODER KUNSTLEDER BEZOGEN.**

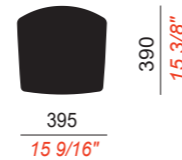

**POLYPROPYLENE PADDED / POLYPROPYLÈNE REMBOURRÉ  
POLIPROPILENO ACOLCHADOS / POLYPROPYLEN GEPOLSTERT**

**PAD  
COUSSIN  
PANEL  
SIZ PLATTE**





# Pigreco

Francesco Meda, 2019

 MADE IN ITALY



TECHNICAL DETAILS / DÉTAILS TECHNIQUES / DETALLES TECNICOS / TECHNISCHE DATEN

MONOSHELL: POLYETHYLENE / MONOCOQUE: POLYÉTHYLÈNE / MONOCASCO: POLIETILENO / MONOBLOCK SCHALE: POLYETHYLEN

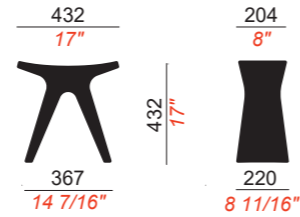

2 LEGS STOOL / TABOURET 2 PIEDS  
TABURETE 2 PATAS / BARHOCKER 2 BEINE

ITEMS PER BOX QUANTITÉ PAR EMBALLAGE CANTIDADES POR CAJA ANZAHL PRO VERPACKUNG	PACKAGING SIZES DIMENSIONS EMBALLAGE DIMENSIONES EMBALAJE VERPACKUNG MASSE	PACKAGING VOLUME VOLUME EMBALLAGE VOLUMEN EMBALAJE VERPACKUNG VOLUMEN	BOX WEIGHT POIDS EMBALLAGE PESO CAJA VERPACKUNG GEWICHT
1	44x22x45	0,04	2,5

POLYETHYLENE COLOURS / COULEURS DU POLYÉTHYLÈNE  
COLORES POLIETILENO / POLYETHYLEN FARBE

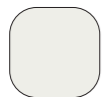

BIANCO

NCS 0500 - N



VERDE FORESTA

NCS 5030 - G30Y



FANGO

NCS 7010-G90Y



MELANZANA

NCS 5540 - Y90R



GRIGIO SCURO

NCS 7500 - N



NERO

NCS 9000 - N







# Re-al 1

Jun Yasumoto, 2024

 MADE IN ITALY

CATAS



TECHNICAL DETAILS / DÉTAILS TECHNIQUES / DETALLES TECNICOS / TECHNISCHE DATEN

FRAME: ALUMINIUM TUBULAR 22 MM / CHÂSSIS : TUBULAIRE EN ALUMINIUM 22 MM / ESTRUCTURA: TUBULAR EN ALUMINIO 22 MM / GESTELL: ALUMINIUMROHR 22 MM

SEAT AND BACKREST: ALUMINIUM SHEET / ASSISE ET DOSSIER: TÔLE D'ALUMINIUM / ASIENTO Y RESPALDO: HOJA DE ALUMINIO / SITZ UND RÜCKEN: ALUMINIUMBLECH

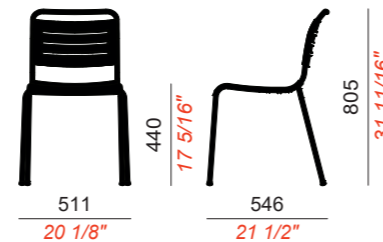
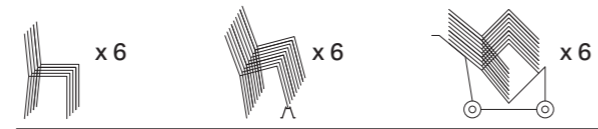

4 LEGS FRAME / CHÂSSIS À 4 PIEDS  
ESTRUCTURA 4 PATAS / GESTELL 4 BEINE

ITEMS PER BOX QUANTITÉ PAR EMBALLAGE CANTIDADES POR CAJA ANZAHL PRO VERPACKUNG	PACKAGING SIZES DIMENSIONS EMBALLAGE DIMENSIONES EMBALAJE VERPACKUNG MASSE	PACKAGING VOLUME VOLUME EMBALLAGE VOLUMEN EMBALAJE VERPACKUNG VOLUMEN	BOX WEIGHT POIDS EMBALLAGE PESO CAJA VERPACKUNG GEWICHT
4	65x54x95	0,33	18,5

\*METAL AND ALUMINIUM COLOURS: SEE ALTERNATIVES ON PAGE 120  
\*COULEURS MÉTAL ET ALUMINIUM : VOIR ALTERNATIVES À LA PAGE 120  
\*COLORES METAL Y ALUMINIO: VER ALTERNATIVAS EN LA PÁGINA 120  
\*METALL- UND ALUMINIUMFARBEN: SIEHE ALTERNATIVEN AUF SEITE 120

VARNISHED ALUMINIUM COLOURS / COULEURS ALUMINIUM VERNI  
COLORES ALUMINIO BARNIZADO / LACKIERTE ALUMINIUM FARBEN



NCS 0500-N	NCS S 2005-Y	NCS S 3005-G50Y	NCS S 3560-Y70R	NCS 7500 - N	NCS 9000 - N	NCS 9000 - N
------------	--------------	-----------------	-----------------	--------------	--------------	--------------

# Re-al 2

Jun Yasumoto, 2024

 MADE IN ITALY

CATAS



TECHNICAL DETAILS / DÉTAILS TECHNIQUES / DETALLES TECNICOS / TECHNISCHE DATEN

FRAME: ALUMINIUM TUBULAR 22 MM / CHÂSSIS : TUBULAIRE EN ALUMINIUM 22 MM / ESTRUCTURA: TUBULAR EN ALUMINIO 22 MM / GESTELL: ALUMINIUMROHR 22 MM

SEAT AND BACKREST: ALUMINIUM SHEET / ASSISE ET DOSSIER: TÔLE D'ALUMINIUM / ASIENTO Y RESPALDO: HOJA DE ALUMINIO / SITZ UND RÜCKEN: ALUMINIUMBLECH

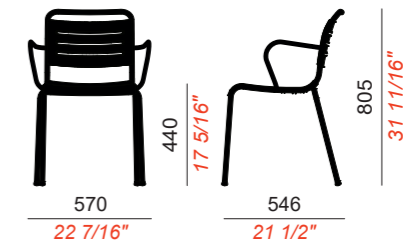
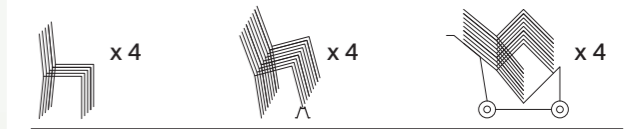

4 LEGS FRAME / CHÂSSIS À 4 PIEDS  
ESTRUCTURA 4 PATAS / GESTELL 4 BEINE

ITEMS PER BOX QUANTITÉ PAR EMBALLAGE CANTIDADES POR CAJA ANZAHL PRO VERPACKUNG	PACKAGING SIZES DIMENSIONS EMBALLAGE DIMENSIONES EMBALAJE VERPACKUNG MASSE	PACKAGING VOLUME VOLUME EMBALLAGE VOLUMEN EMBALAJE VERPACKUNG VOLUMEN	BOX WEIGHT POIDS EMBALLAGE PESO CAJA VERPACKUNG GEWICHT
4	77x59x92	0,41	21

\*METAL AND ALUMINIUM COLOURS: SEE ALTERNATIVES ON PAGE 120  
\*COULEURS MÉTAL ET ALUMINIUM : VOIR ALTERNATIVES À LA PAGE 120  
\*COLORES METAL Y ALUMINIO: VER ALTERNATIVAS EN LA PÁGINA 120  
\*METALL- UND ALUMINIUMFARBEN: SIEHE ALTERNATIVEN AUF SEITE 120

VARNISHED ALUMINIUM COLOURS / COULEURS ALUMINIUM VERNI  
COLORES ALUMINIO BARNIZADO / LACKIERTE ALUMINIUM FARBEN



NCS 0500-N	NCS S 2005-Y	NCS S 3005-G50Y	NCS S 3560-Y70R	NCS 7500 - N	NCS 9000 - N	NCS 9000 - N
------------	--------------	-----------------	-----------------	--------------	--------------	--------------

# Villa

Jun Yasumoto, 2018/2019/2021



# Villa 1

Jun Yasumoto, 2018

 MADE IN ITALY



OUTDOOR

TECHNICAL DETAILS / DÉTAILS TECHNIQUES / DETALLES TECNICOS / TECHNISCHE DATEN

FRAME: TUBULAR METAL 14 MM / CHÂSSIS: TUBE D'ACIER 14 MM  
ESTRUCTURA: TUBULAR EN METAL 14 MM / GESTELL: STAHLROHR 14 MM

SHELL: METAL MESH / COQUE: RESILLE METALIQUE  
CARCASA: MALLA METALICA / SITZSCHALE: MASCHENDRAHTZAUN

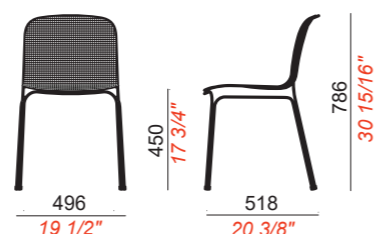
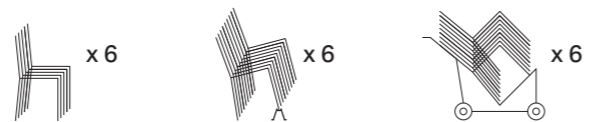

4 LEGS FRAME / CHÂSSIS À 4 PIEDS  
ESTRUCTURA 4 PATAS / GESTELL 4 BEINE

ITEMS PER BOX QUANTITÉ PAR EMBALLAGE CANTIDADES POR CAJA ANZAHL PRO VERPACKUNG	PACKAGING SIZES DIMENSIONS EMBALLAGE DIMENSIONES EMBALAJE VERPACKUNG MASSE	PACKAGING VOLUME VOLUME EMBALLAGE VOLUMEN EMBALAJE VERPACKUNG VOLUMEN	BOX WEIGHT POIDS EMBALLAGE PESO CAJA VERPACKUNG GEWICHT
4	78x60x99	0,46	23

\*METAL AND ALUMINIUM COLOURS: SEE ALTERNATIVES ON PAGE 120  
\*COULEURS MÉTAL ET ALUMINIUM : VOIR ALTERNATIVES À LA PAGE 120  
\*COLORES METAL Y ALUMINIO: VER ALTERNATIVAS EN LA PÁGINA 120  
\*METALL- UND ALUMINIUMFARBEN: SIEHE ALTERNATIVEN AUF SEITE 120

VARNISHED METAL COLOURS / COULEURS MÉTAL VERNI  
COLORES METAL BARNIZADO / LACKIERTE METALL FARBEN



BIANCO      TORRENTE      MELANZANA      VERDE SCURO      GRIGIO SCURO      NERO

NCS 0500-N    NCS S 3005-G50Y    NCS 5540 - Y90R    NCS 8010-G10Y    NCS 7500 - N    NCS 9000 - N

# Villa 2

Jun Yasumoto, 2018

 MADE IN ITALY



OUTDOOR

TECHNICAL DETAILS / DÉTAILS TECHNIQUES / DETALLES TECNICOS / TECHNISCHE DATEN

FRAME: TUBULAR METAL 14 MM / CHÂSSIS: TUBE D'ACIER 14 MM  
ESTRUCTURA: TUBULAR EN METAL 14 MM / GESTELL: STAHLROHR 14 MM

SHELL: METAL MESH / COQUE: RESILLE METALIQUE  
CARCASA: MALLA METALICA / SITZSCHALE: MASCHENDRAHTZAUN

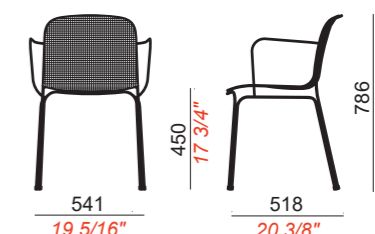
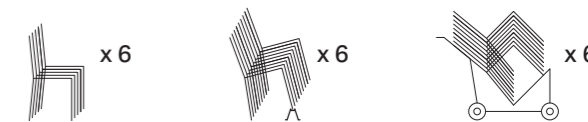

4 LEGS FRAME / CHÂSSIS À 4 PIEDS  
ESTRUCTURA 4 PATAS / GESTELL 4 BEINE

ITEMS PER BOX QUANTITÉ PAR EMBALLAGE CANTIDADES POR CAJA ANZAHL PRO VERPACKUNG	PACKAGING SIZES DIMENSIONS EMBALLAGE DIMENSIONES EMBALAJE VERPACKUNG MASSE	PACKAGING VOLUME VOLUME EMBALLAGE VOLUMEN EMBALAJE VERPACKUNG VOLUMEN	BOX WEIGHT POIDS EMBALLAGE PESO CAJA VERPACKUNG GEWICHT
4	78x60x99	0,46	26

\*METAL AND ALUMINIUM COLOURS: SEE ALTERNATIVES ON PAGE 120  
\*COULEURS MÉTAL ET ALUMINIUM : VOIR ALTERNATIVES À LA PAGE 120  
\*COLORES METAL Y ALUMINIO: VER ALTERNATIVAS EN LA PÁGINA 120  
\*METALL- UND ALUMINIUMFARBEN: SIEHE ALTERNATIVEN AUF SEITE 120

VARNISHED METAL COLOURS / COULEURS MÉTAL VERNI  
COLORES METAL BARNIZADO / LACKIERTE METALL FARBEN



BIANCO      TORRENTE      MELANZANA      VERDE SCURO      GRIGIO SCURO      NERO

NCS 0500-N    NCS S 3005-G50Y    NCS 5540 - Y90R    NCS 8010-G10Y    NCS 7500 - N    NCS 9000 - N

# Villa 3A

Jun Yasumoto, 2019

 MADE IN ITALY



TECHNICAL DETAILS / DÉTAILS TECHNIQUES / DETALLES TECNICOS / TECHNISCHE DATEN

FRAME: TUBULAR METAL 14 MM / CHÂSSIS: TUBE D'ACIER 14 MM  
ESTRUCTURA: TUBULAR EN METAL 14 MM / GESTELL: STAHLROHR 14 MM

SHELL: METAL MESH / COQUE: RESILLE METALIQUE  
CARCASA: MALLA METALICA / SITZSCHALE: MASCHENDRAHTZAUN

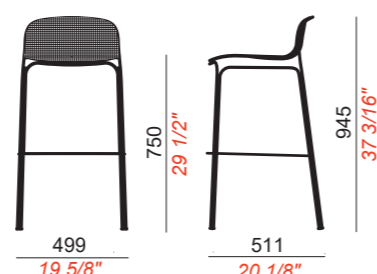
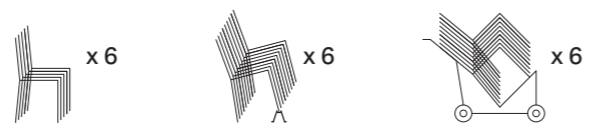

4 LEGS FRAME H:750 / CHÂSSIS À 4 PIEDS H:750  
ESTRUCTURA 4 PATAS H:750 / GESTELL 4 BEINE H:750

ITEMS PER BOX QUANTITÉ PAR EMBALLAGE CANTIDADES POR CAJA ANZAHL PRO VERPACKUNG	PACKAGING SIZES DIMENSIONS EMBALLAGE DIMENSIONES EMBALAJE VERPACKUNG MASSE	PACKAGING VOLUME VOLUME EMBALLAGE VOLUMEN EMBALAJE VERPACKUNG VOLUMEN	BOX WEIGHT POIDS EMBALLAGE PESO CAJA VERPACKUNG GEWICHT
2	52x57x115	0,34	14,5

\*METAL AND ALUMINIUM COLOURS: SEE ALTERNATIVES ON PAGE 120  
\*COULEURS MÉTAL ET ALUMINIUM : VOIR ALTERNATIVES À LA PAGE 120  
\*COLORES METAL Y ALUMINIO: VER ALTERNATIVAS EN LA PÁGINA 120  
\*METALL- UND ALUMINIUMFARBEN: SIEHE ALTERNATIVEN AUF SEITE 120

VARNISHED METAL COLOURS / COULEURS MÉTAL VERNI  
COLORES METAL BARNIZADO / LACKIERTE METALL FARBEN



BIANCO    TORRENTE    MELANZANA    VERDE SCURO    GRIGIO SCURO    NERO

NCS 0500-N    NCS S 3005-G50Y    NCS 5540 - Y90R    NCS 8010-G10Y    NCS 7500 - N    NCS 9000 - N

# Villa Cus

Jun Yasumoto, 2021

 MADE IN ITALY



TECHNICAL DETAILS / DÉTAILS TECHNIQUES / DETALLES TECNICOS / TECHNISCHE DATEN

VILLA CUSHION IN SUNBRELLA® FABRIC FOR OUTDOOR. / VILLA  
COUSSIN EN TISSU SUNBRELLA® POUR OUTDOOR.  
VILLA COJÍN DE TELA SUNBRELLA® PARA EXTERIORES. / VILLA  
KISSEN IN SUNBRELLA® STOFF FÜR DEN AUSSENBEREICH.

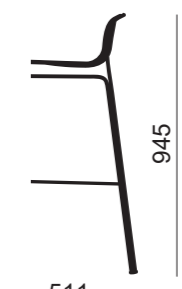

CUSHION IN FABRIC / COUSSIN EN TISSU  
COJÍN EN TELA / KISSEN AUS STOFF

FABRIC COLOURS / COULEURS DE TISSU  
COLORES DE TELA / STOFF FARBEN



GRIGIO CHIARO    GRIGIO SCURO

NAT 10022 140    NAT 10063 140



# C1.1/1

Fabian Schwaerzler, 2016

 MADE IN ITALY

CATAS



TECHNICAL DETAILS / DÉTAILS TECHNIQUES / DETALLES TECNICOS / TECHNISCHE DATEN

FRAME: TUBULAR METAL 20 MM / CHÂSSIS: TUBE D'ACIER 20 MM  
ESTRUCTURA: TUBULAR EN METAL 20 MM / GESTELL: STAHLROHR 20 MM

SEAT/BACKREST: METAL SHEET / ASSISE/DOSSIER: TÔLE  
ASIENTO/RESPALDO: HOJA DE METAL / SITZ/RÜCKENLEHNE: BLECH

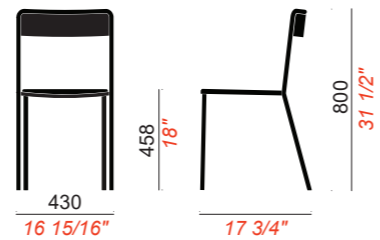
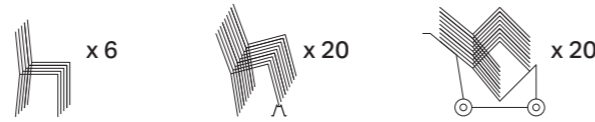

4 LEGS FRAME / CHÂSSIS À 4 PIEDS  
ESTRUCTURA 4 PATAS / GESTELL 4 BEINE

ITEMS PER BOX QUANTITÉ PAR EMBALLAGE CANTIDADES POR CAJA ANZAHL PRO VERPACKUNG	PACKAGING SIZES DIMENSIONS EMBALLAGE DIMENSIONES EMBALAJE VERPACKUNG MASSE	PACKAGING VOLUME VOLUME EMBALLAGE VOLUMEN EMBALAJE VERPACKUNG VOLUMEN	BOX WEIGHT POIDS EMBALLAGE PESO CAJA VERPACKUNG GEWICHT
4	67x50x96	0,32	25

\*METAL AND ALUMINIUM COLOURS: SEE ALTERNATIVES ON PAGE 120  
\*COULEURS MÉTAL ET ALUMINIUM : VOIR ALTERNATIVES À LA PAGE 120  
\*COLORES METAL Y ALUMINIO: VER ALTERNATIVAS EN LA PÁGINA 120  
\*METALL- UND ALUMINIUMFARBEN: SIEHE ALTERNATIVEN AUF SEITE 120

VARNISHED METAL COLOURS / COULEURS MÉTAL VERNI  
COLORES METAL BARNIZADO / LACKIERTE METALL FARBEN



BIANCO    SENAPE    ROSSO    MELANZANA    VERDE SCURO    GRIGIO SCURO    NERO

NCS 0500-N	NCS 2070 - Y10R	NCS 1085-Y90R	NCS 5540 - Y90R	NCS 8010-G10Y	NCS 7500 - N	NCS 9000 - N
------------	-----------------	---------------	-----------------	---------------	--------------	--------------

# C1.1/4

Fabian Schwaerzler, 2016

 MADE IN ITALY

CATAS



TECHNICAL DETAILS / DÉTAILS TECHNIQUES / DETALLES TECNICOS / TECHNISCHE DATEN

FRAME: TUBULAR METAL 20 MM / CHÂSSIS: TUBE D'ACIER 20 MM  
ESTRUCTURA: TUBULAR EN METAL 20 MM / GESTELL: STAHLROHR 20 MM

SEAT/BACKREST: METAL SHEET / ASSISE/DOSSIER: TÔLE  
ASIENTO/RESPALDO: HOJA DE METAL / SITZ/RÜCKENLEHNE: BLECH

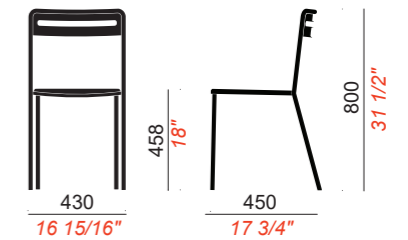
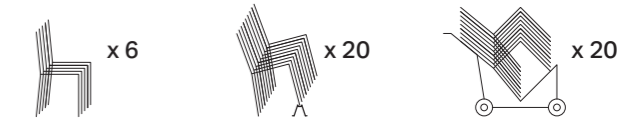

4 LEGS FRAME / CHÂSSIS À 4 PIEDS  
ESTRUCTURA 4 PATAS / GESTELL 4 BEINE

ITEMS PER BOX QUANTITÉ PAR EMBALLAGE CANTIDADES POR CAJA ANZAHL PRO VERPACKUNG	PACKAGING SIZES DIMENSIONS EMBALLAGE DIMENSIONES EMBALAJE VERPACKUNG MASSE	PACKAGING VOLUME VOLUME EMBALLAGE VOLUMEN EMBALAJE VERPACKUNG VOLUMEN	BOX WEIGHT POIDS EMBALLAGE PESO CAJA VERPACKUNG GEWICHT
4	67x50x96	0,32	25

\*METAL AND ALUMINIUM COLOURS: SEE ALTERNATIVES ON PAGE 120  
\*COULEURS MÉTAL ET ALUMINIUM : VOIR ALTERNATIVES À LA PAGE 120  
\*COLORES METAL Y ALUMINIO: VER ALTERNATIVAS EN LA PÁGINA 120  
\*METALL- UND ALUMINIUMFARBEN: SIEHE ALTERNATIVEN AUF SEITE 120

VARNISHED METAL COLOURS / COULEURS MÉTAL VERNI  
COLORES METAL BARNIZADO / LACKIERTE METALL FARBEN



BIANCO    SENAPE    ROSSO    MELANZANA    VERDE SCURO    GRIGIO SCURO    NERO

NCS 0500-N	NCS 2070 - Y10R	NCS 1085-Y90R	NCS 5540 - Y90R	NCS 8010-G10Y	NCS 7500 - N	NCS 9000 - N
------------	-----------------	---------------	-----------------	---------------	--------------	--------------

# C1.2/1

Fabian Schwaerzler, 2016

 MADE IN ITALY



TECHNICAL DETAILS / DÉTAILS TECHNIQUES / DETALLES TECNICOS / TECHNISCHE DATEN

FRAME: TUBULAR METAL 20 MM / CHÂSSIS: TUBE D'ACIER 20 MM  
ESTRUCTURA: TUBULAR EN METAL 20 MM / GESTELL: STAHLROHR 20 MM

SEAT/BACKREST: METAL SHEET / ASSISE/DOSSIER: TÔLE  
ASIENTO/RESPALDO: HOJA DE METAL / SITZ/RÜCKENLEHNE: BLECH

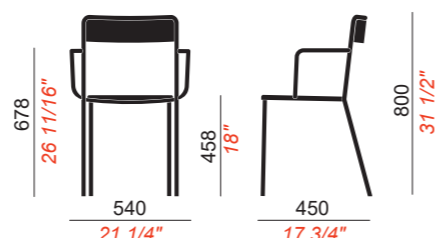
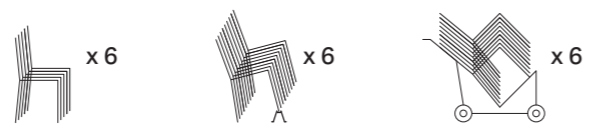

4 LEGS FRAME / CHÂSSIS À 4 PIEDS  
ESTRUCTURA 4 PATAS / GESTELL 4 BEINE

ITEMS PER BOX QUANTITÉ PAR EMBALLAGE CANTIDADES POR CAJA ANZAHL PRO VERPACKUNG	PACKAGING SIZES DIMENSIONS EMBALLAGE DIMENSIONES EMBALAJE VERPACKUNG MASSE	PACKAGING VOLUME VOLUME EMBALLAGE VOLUMEN EMBALAJE VERPACKUNG VOLUMEN	BOX WEIGHT POIDS EMBALLAGE PESO CAJA VERPACKUNG GEWICHT
4	60x78x93	0,43	28

\*METAL AND ALUMINIUM COLOURS: SEE ALTERNATIVES ON PAGE 120  
\*COULEURS MÉTAL ET ALUMINIUM : VOIR ALTERNATIVES À LA PAGE 120  
\*COLORES METAL Y ALUMINIO: VER ALTERNATIVAS EN LA PÁGINA 120  
\*METALL- UND ALUMINIUMFARBEN: SIEHE ALTERNATIVEN AUF SEITE 120

VARNISHED METAL COLOURS / COULEURS MÉTAL VERNI  
COLORES METAL BARNIZADO / LACKIERTE METALL FARBEN



BIANCO    SENAPE    ROSSO    MELANZANA    VERDE SCURO    GRIGIO SCURO    NERO

NCS 0500-N	NCS 2070 - Y10R	NCS 1085-Y90R	NCS 5540 - Y90R	NCS 8010-G10Y	NCS 7500 - N	NCS 9000 - N
------------	-----------------	---------------	-----------------	---------------	--------------	--------------

# C1.2/4

Fabian Schwaerzler, 2016

 MADE IN ITALY



TECHNICAL DETAILS / DÉTAILS TECHNIQUES / DETALLES TECNICOS / TECHNISCHE DATEN

FRAME: TUBULAR METAL 20 MM / CHÂSSIS: TUBE D'ACIER 20 MM  
ESTRUCTURA: TUBULAR EN METAL 20 MM / GESTELL: STAHLROHR 20 MM

SEAT/BACKREST: METAL SHEET / ASSISE/DOSSIER: TÔLE  
ASIENTO/RESPALDO: HOJA DE METAL / SITZ/RÜCKENLEHNE: BLECH

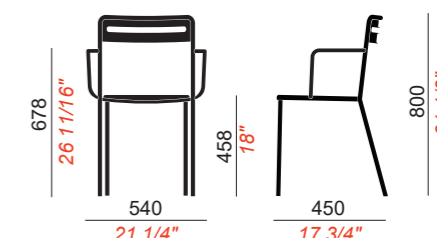
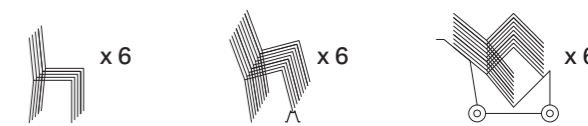

4 LEGS FRAME / CHÂSSIS À 4 PIEDS  
ESTRUCTURA 4 PATAS / GESTELL 4 BEINE

ITEMS PER BOX QUANTITÉ PAR EMBALLAGE CANTIDADES POR CAJA ANZAHL PRO VERPACKUNG	PACKAGING SIZES DIMENSIONS EMBALLAGE DIMENSIONES EMBALAJE VERPACKUNG MASSE	PACKAGING VOLUME VOLUME EMBALLAGE VOLUMEN EMBALAJE VERPACKUNG VOLUMEN	BOX WEIGHT POIDS EMBALLAGE PESO CAJA VERPACKUNG GEWICHT
4	60x78x93	0,43	28

\*METAL AND ALUMINIUM COLOURS: SEE ALTERNATIVES ON PAGE 120  
\*COULEURS MÉTAL ET ALUMINIUM : VOIR ALTERNATIVES À LA PAGE 120  
\*COLORES METAL Y ALUMINIO: VER ALTERNATIVAS EN LA PÁGINA 120  
\*METALL- UND ALUMINIUMFARBEN: SIEHE ALTERNATIVEN AUF SEITE 120

VARNISHED METAL COLOURS / COULEURS MÉTAL VERNI  
COLORES METAL BARNIZADO / LACKIERTE METALL FARBEN



BIANCO    SENAPE    ROSSO    MELANZANA    VERDE SCURO    GRIGIO SCURO    NERO

NCS 0500-N	NCS 2070 - Y10R	NCS 1085-Y90R	NCS 5540 - Y90R	NCS 8010-G10Y	NCS 7500 - N	NCS 9000 - N
------------	-----------------	---------------	-----------------	---------------	--------------	--------------





# Stecca 1

Alban Le Henry, 2016

 MADE IN ITALY

CATAS



TECHNICAL DETAILS / DÉTAILS TECHNIQUES / DETALLES TECNICOS / TECHNISCHE DATEN

FRAME: TUBULAR ALUMINIUM 25 MM / CHÂSSIS: TUBE D'ALUMINIUM 25 MM  
ESTRUCTURA: TUBULAR EN ALUMINIO 25 MM / GESTELL: ALUMINIUMROHR 25 MM

SLATS: ALUMINIUM SHEET / LATTES: TÔLE D'ALUMINIUM  
LISTONES: HOJA DE ALUMINIO / LATTEN: AUS ALUMINIUM

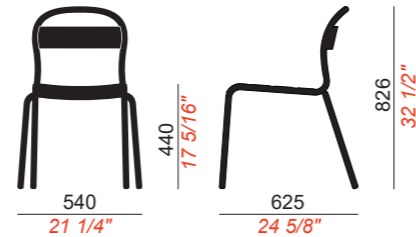

4 LEGS FRAME / CHÂSSIS À 4 PIEDS  
ESTRUCTURA 4 PATAS / GESTELL 4 BEINE

ITEMS PER BOX QUANTITÉ PAR EMBALLAGE CANTIDADES POR CAJA ANZAHL PRO VERPACKUNG	PACKAGING SIZES DIMENSIONS EMBALLAGE DIMENSIONES EMBALAJE VERPACKUNG MASSE	PACKAGING VOLUME VOLUME EMBALLAGE VOLUMEN EMBALAJE VERPACKUNG VOLUMEN	BOX WEIGHT POIDS EMBALLAGE PESO CAJA VERPACKUNG GEWICHT
4	60x78x93	0,43	17

\*METAL AND ALUMINIUM COLOURS: SEE ALTERNATIVES ON PAGE 120  
\*COULEURS MÉTAL ET ALUMINIUM : VOIR ALTERNATIVES À LA PAGE 120  
\*COLORES METAL Y ALUMINIO: VER ALTERNATIVAS EN LA PÁGINA 120  
\*METALL- UND ALUMINIUMFARBEN: SIEHE ALTERNATIVEN AUF SEITE 120

VARNISHED ALUMINIUM COLOURS / COULEURS ALUMINIUM VERNI  
COLORES ALUMINIO BARNIZADO / LACKIERTE ALU FARBEN



BIANCO    SENAPE    GRIGIO SCURO    VERDE SCURO    MELANZANA    BLU SCURO    NERO

NCS 0500-N	NCS 2070 - Y10R	NCS 7500 - N	NCS 8010 - G10Y	NCS 5540 - Y90R	NCS 6030 - R80B	NCS 9000 - N
------------	-----------------	--------------	-----------------	-----------------	-----------------	--------------

# Stecca 2

Alban Le Henry, 2016

 MADE IN ITALY

CATAS



TECHNICAL DETAILS / DÉTAILS TECHNIQUES / DETALLES TECNICOS / TECHNISCHE DATEN

FRAME: TUBULAR ALUMINIUM 25 MM / CHÂSSIS: TUBE D'ALUMINIUM 25 MM  
ESTRUCTURA: TUBULAR EN ALUMINIO 25 MM / GESTELL: ALUMINIUMROHR 25 MM

SLATS: ALUMINIUM SHEET / LATTES: TÔLE D'ALUMINIUM  
LISTONES: HOJA DE ALUMINIO / LATTEN: AUS ALUMINIUM

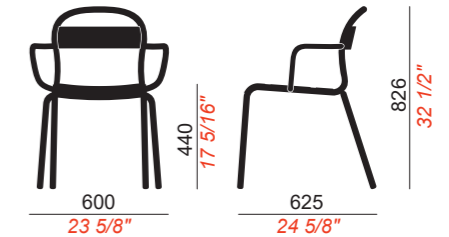

4 LEGS FRAME / CHÂSSIS À 4 PIEDS  
ESTRUCTURA 4 PATAS / GESTELL 4 BEINE

ITEMS PER BOX QUANTITÉ PAR EMBALLAGE CANTIDADES POR CAJA ANZAHL PRO VERPACKUNG	PACKAGING SIZES DIMENSIONS EMBALLAGE DIMENSIONES EMBALAJE VERPACKUNG MASSE	PACKAGING VOLUME VOLUME EMBALLAGE VOLUMEN EMBALAJE VERPACKUNG VOLUMEN	BOX WEIGHT POIDS EMBALLAGE PESO CAJA VERPACKUNG GEWICHT
4	60x78x93	0,43	19

\*METAL AND ALUMINIUM COLOURS: SEE ALTERNATIVES ON PAGE 120  
\*COULEURS MÉTAL ET ALUMINIUM : VOIR ALTERNATIVES À LA PAGE 120  
\*COLORES METAL Y ALUMINIO: VER ALTERNATIVAS EN LA PÁGINA 120  
\*METALL- UND ALUMINIUMFARBEN: SIEHE ALTERNATIVEN AUF SEITE 120

VARNISHED ALUMINIUM COLOURS / COULEURS ALUMINIUM VERNI  
COLORES ALUMINIO BARNIZADO / LACKIERTE ALU FARBEN



BIANCO    SENAPE    GRIGIO SCURO    VERDE SCURO    MELANZANA    BLU SCURO    NERO

NCS 0500-N	NCS 2070 - Y10R	NCS 7500 - N	NCS 8010 - G10Y	NCS 5540 - Y90R	NCS 6030 - R80B	NCS 9000 - N
------------	-----------------	--------------	-----------------	-----------------	-----------------	--------------

# Stecca 5

Alban Le Henry, 2016

 MADE IN ITALY



OUTDOOR



**TECHNICAL DETAILS / DÉTAILS TECHNIQUES / DETALLES TECNICOS / TECHNISCHE DATEN**

**FRAME: TUBULAR ALUMINIUM 25 MM / CHÂSSIS: TUBE D'ALUMINIUM 25 MM**  
 ESTRUCTURA: TUBULAR EN ALUMINIO 25 MM / GESTELL: ALUMINIUMROHR 25 MM

**SLATS: ALUMINIUM SHEET / LATTES: TÔLE D'ALUMINIUM**  
 LISTONES: HOJA DE ALUMINIO / LATTEN: AUS ALUMINIUM

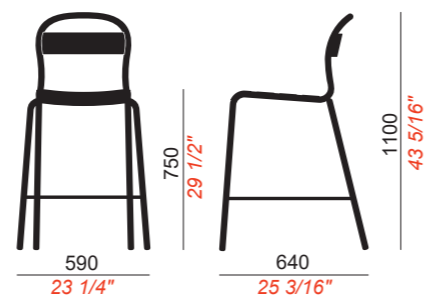
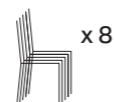

**4 LEGS FRAME H:750 / CHÂSSIS À 4 PIEDS H:750**  
 ESTRUCTURA 4 PATAS H:750 / GESTELL 4 BEINE H:750

ITEMS PER BOX QUANTITÉ PAR EMBALLAGE CANTIDADES POR CAJA ANZAHL PRO VERPACKUNG	PACKAGING SIZES DIMENSIONS EMBALLAGE DIMENSIONES EMBALAJE VERPACKUNG MASSE	PACKAGING VOLUME VOLUME EMBALLAGE VOLUMEN EMBALAJE VERPACKUNG VOLUMEN	BOX WEIGHT POIDS EMBALLAGE PESO CAJA VERPACKUNG GEWICHT
2	68x62x120	0,50	13

\*METAL AND ALUMINIUM COLOURS: SEE ALTERNATIVES ON PAGE 120  
 \*COULEURS MÉTAL ET ALUMINIUM : VOIR ALTERNATIVES À LA PAGE 120  
 \*COLORES METAL Y ALUMINIO: VER ALTERNATIVAS EN LA PÁGINA 120  
 \*METALL- UND ALUMINIUMFARBEN: SIEHE ALTERNATIVEN AUF SEITE 120

**VARNISHED ALUMINIUM COLOURS / COULEURS ALUMINIUM VERNI**  
 COLORES ALUMINIO BARNIZADO / LACKIERTE ALU FARBEN



BIANCO SENAPE GRIGIO SCURO VERDE SCURO MELANZANA BLU SCURO NERO

NCS 0500-N	NCS 2070 - Y10R	NCS 7500 - N	NCS 8010 - G10Y	NCS 5540 - Y90R	NCS 6030 - R80B	NCS 9000 - N
------------	-----------------	--------------	-----------------	-----------------	-----------------	--------------

# Stecca 6

Alban Le Henry, 2016

 MADE IN ITALY



OUTDOOR



**TECHNICAL DETAILS / DÉTAILS TECHNIQUES / DETALLES TECNICOS / TECHNISCHE DATEN**

**FRAME: TUBULAR ALUMINIUM 25 MM / CHÂSSIS: TUBE D'ALUMINIUM 25 MM**  
 ESTRUCTURA: TUBULAR EN ALUMINIO 25 MM / GESTELL: ALUMINIUMROHR 25 MM

**SLATS: ALUMINIUM SHEET / LATTES: TÔLE D'ALUMINIUM**  
 LISTONES: HOJA DE ALUMINIO / LATTEN: AUS ALUMINIUM

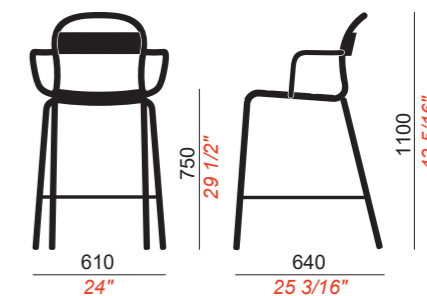
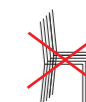

**4 LEGS FRAME H:750 / CHÂSSIS À 4 PIEDS H:750**  
 ESTRUCTURA 4 PATAS H:750 / GESTELL 4 BEINE H:750

ITEMS PER BOX QUANTITÉ PAR EMBALLAGE CANTIDADES POR CAJA ANZAHL PRO VERPACKUNG	PACKAGING SIZES DIMENSIONS EMBALLAGE DIMENSIONES EMBALAJE VERPACKUNG MASSE	PACKAGING VOLUME VOLUME EMBALLAGE VOLUMEN EMBALAJE VERPACKUNG VOLUMEN	BOX WEIGHT POIDS EMBALLAGE PESO CAJA VERPACKUNG GEWICHT
1	68x62x120	0,50	7

\*METAL AND ALUMINIUM COLOURS: SEE ALTERNATIVES ON PAGE 120  
 \*COULEURS MÉTAL ET ALUMINIUM : VOIR ALTERNATIVES À LA PAGE 120  
 \*COLORES METAL Y ALUMINIO: VER ALTERNATIVAS EN LA PÁGINA 120  
 \*METALL- UND ALUMINIUMFARBEN: SIEHE ALTERNATIVEN AUF SEITE 120

**VARNISHED ALUMINIUM COLOURS / COULEURS ALUMINIUM VERNI**  
 COLORES ALUMINIO BARNIZADO / LACKIERTE ALU FARBEN



BIANCO SENAPE GRIGIO SCURO VERDE SCURO MELANZANA BLU SCURO NERO

NCS 0500-N	NCS 2070 - Y10R	NCS 7500 - N	NCS 8010 - G10Y	NCS 5540 - Y90R	NCS 6030 - R80B	NCS 9000 - N
------------	-----------------	--------------	-----------------	-----------------	-----------------	--------------

# Stecca 7

Alban Le Henry, 2016

 MADE IN ITALY



OUTDOOR

**TECHNICAL DETAILS / DÉTAILS TECHNIQUES / DETALLES TECNICOS / TECHNISCHE DATEN**

**FRAME: TUBULAR ALUMINIUM 25 MM / CHÂSSIS: TUBE D'ALUMINIUM 25 MM**  
 ESTRUCTURA: TUBULAR EN ALUMINIO 25 MM / GESTELL: ALUMINIUMROHR 25 MM

**SLATS: ALUMINIUM SHEET / LATTES: TÔLE D'ALUMINIUM**  
 LISTONES: HOJA DE ALUMINIO / LATTEN: AUS ALUMINIUM



**4 LEGS FRAME / CHÂSSIS À 4 PIEDS**  
 ESTRUCTURA 4 PATAS / GESTELL 4 BEINE

ITEMS PER BOX QUANTITÉ PAR EMBALLAGE CANTIDADES POR CAJA ANZAHL PRO VERPACKUNG	PACKAGING SIZES DIMENSIONS EMBALLAGE DIMENSIONES EMBALAJE VERPACKUNG MASSE	PACKAGING VOLUME VOLUME EMBALLAGE VOLUMEN EMBALAJE VERPACKUNG VOLUMEN	BOX WEIGHT POIDS EMBALLAGE PESO CAJA VERPACKUNG GEWICHT
1	44x47x46	0,10	2

\*METAL AND ALUMINIUM COLOURS: SEE ALTERNATIVES ON PAGE 120  
 \*COULEURS MÉTAL ET ALUMINIUM : VOIR ALTERNATIVES À LA PAGE 120  
 \*COLORES METAL Y ALUMINIO: VER ALTERNATIVAS EN LA PÁGINA 120  
 \*METALL- UND ALUMINIUMFARBEN: SIEHE ALTERNATIVEN AUF SEITE 120

**VARNISHED ALUMINIUM COLOURS / COULEURS ALUMINIUM VERNI**  
 COLORES ALUMINIO BARNIZADO / LACKIERTE ALU FARBEN



BIANCO    SENAPE    GRIGIO SCURO    VERDE SCURO    MELANZANA    BLU SCURO    NERO

NCS 0500-N	NCS 2070 - Y10R	NCS 7500 - N	NCS 8010 - G10Y	NCS 5540 - Y90R	NCS 6030 - R80B	NCS 9000 - N
------------	-----------------	--------------	-----------------	-----------------	-----------------	--------------

# Stecca 8

Alban Le Henry, 2016

 MADE IN ITALY



OUTDOOR

**TECHNICAL DETAILS / DÉTAILS TECHNIQUES / DETALLES TECNICOS / TECHNISCHE DATEN**

**FRAME: TUBULAR ALUMINIUM 25 MM / CHÂSSIS: TUBE D'ALUMINIUM 25 MM**  
 ESTRUCTURA: TUBULAR EN ALUMINIO 25 MM / GESTELL: ALUMINIUMROHR 25 MM

**SLATS: ALUMINIUM SHEET / LATTES: TÔLE D'ALUMINIUM**  
 LISTONES: HOJA DE ALUMINIO / LATTEN: AUS ALUMINIUM

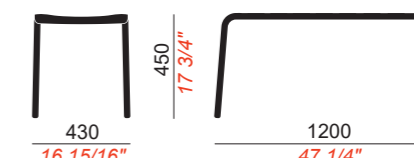
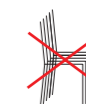
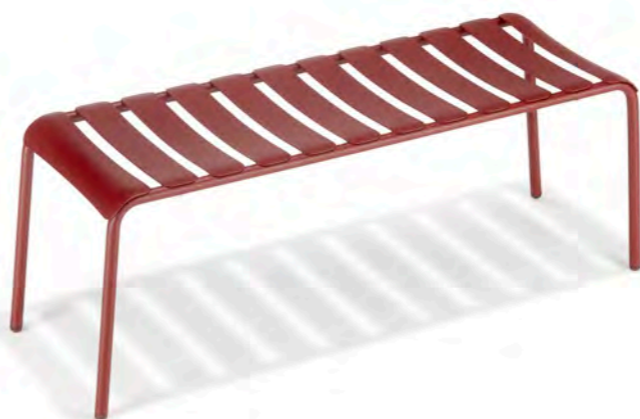

**4 LEGS FRAME / CHÂSSIS À 4 PIEDS**  
 ESTRUCTURA 4 PATAS / GESTELL 4 BEINE

ITEMS PER BOX QUANTITÉ PAR EMBALLAGE CANTIDADES POR CAJA ANZAHL PRO VERPACKUNG	PACKAGING SIZES DIMENSIONS EMBALLAGE DIMENSIONES EMBALAJE VERPACKUNG MASSE	PACKAGING VOLUME VOLUME EMBALLAGE VOLUMEN EMBALAJE VERPACKUNG VOLUMEN	BOX WEIGHT POIDS EMBALLAGE PESO CAJA VERPACKUNG GEWICHT
1	44x130x48	0,27	9

\*METAL AND ALUMINIUM COLOURS: SEE ALTERNATIVES ON PAGE 120  
 \*COULEURS MÉTAL ET ALUMINIUM : VOIR ALTERNATIVES À LA PAGE 120  
 \*COLORES METAL Y ALUMINIO: VER ALTERNATIVAS EN LA PÁGINA 120  
 \*METALL- UND ALUMINIUMFARBEN: SIEHE ALTERNATIVEN AUF SEITE 120

**VARNISHED ALUMINIUM COLOURS / COULEURS ALUMINIUM VERNI**  
 COLORES ALUMINIO BARNIZADO / LACKIERTE ALU FARBEN



BIANCO    SENAPE    GRIGIO SCURO    VERDE SCURO    MELANZANA    BLU SCURO    NERO

NCS 0500-N	NCS 2070 - Y10R	NCS 7500 - N	NCS 8010 - G10Y	NCS 5540 - Y90R	NCS 6030 - R80B	NCS 9000 - N
------------	-----------------	--------------	-----------------	-----------------	-----------------	--------------

# Stecca L

Alban Le Henry, 2018

 MADE IN ITALY



OUTDOOR

**TECHNICAL DETAILS / DÉTAILS TECHNIQUES / DETALLES TECNICOS / TECHNISCHE DATEN**

**FRAME: TUBULAR ALUMINIUM 25 MM / CHÂSSIS: TUBE D'ALUMINIUM 25 MM**

ESTRUCTURA: TUBULAR EN ALUMINIO 25 MM / GESTELL: ALUMINIUMROHR 25 MM

**SLATS: ALUMINIUM SHEET / LATTES: TÔLE D'ALUMINIUM**

LISTONES: HOJA DE ALUMINIO / LATTEN: AUS ALUMINIUM

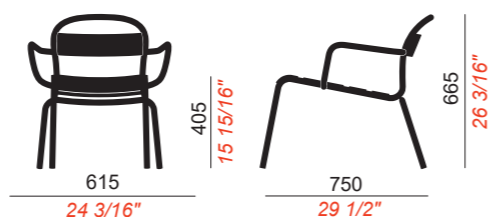
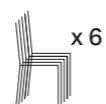

**4 LEGS FRAME / CHÂSSIS À 4 PIEDS**  
ESTRUCTURA 4 PATAS / GESTELL 4 BEINE

ITEMS PER BOX QUANTITÉ PAR EMBALLAGE CANTIDADES POR CAJA ANZAHL PRO VERPACKUNG	PACKAGING SIZES DIMENSIONS EMBALLAGE DIMENSIONES EMBALAJE VERPACKUNG MASSE	PACKAGING VOLUME VOLUME EMBALLAGE VOLUMEN EMBALAJE VERPACKUNG VOLUMEN	BOX WEIGHT POIDS EMBALLAGE PESO CAJA VERPACKUNG GEWICHT
2	80x63x76	0,38	11

\*METAL AND ALUMINIUM COLOURS: SEE ALTERNATIVES ON PAGE 120  
\*COULEURS MÉTAL ET ALUMINIUM : VOIR ALTERNATIVES À LA PAGE 120  
\*COLORES METAL Y ALUMINIO: VER ALTERNATIVAS EN LA PÁGINA 120  
\*METALL- UND ALUMINIUMFARBEN: SIEHE ALTERNATIVEN AUF SEITE 120

**VARNISHED ALUMINIUM COLOURS / COULEURS ALUMINIUM VERNI**  
COLORES ALUMINIO BARNIZADO / LACKIERTE ALU FARBEN



BIANCO    SENAPE    GRIGIO SCURO    VERDE SCURO    MELANZANA    BLU SCURO    NERO

NCS 0500-N    NCS 2070 - Y10R    NCS 7500 - N    NCS 8010 - G10Y    NCS 5540 - Y90R    NCS 6030 - R80B    NCS 9000 - N



# Momo Net

Jeremiah Ferrarese, 2020



# Momo Net 1

Jeremiah Ferrarese, 2020

 MADE IN ITALY



OUTDOOR

TECHNICAL DETAILS / DÉTAILS TECHNIQUES / DETALLES TECNICOS / TECHNISCHE DATEN

FRAME: TUBULAR METAL 25 MM / CHÂSSIS: TUBE EN MÉTAL 25 MM  
ESTRUCTURA: TUBULAR EN METAL 25 MM / GESTELL: STAHLROHR 25 MM

SEAT/BACKREST: METAL MESH / COQUE: MAILLE MÉTALLIQUE  
CARCASA: MALLA METÁLICA / SITZ/RÜCKENLEHNE: METALLGEWEBE

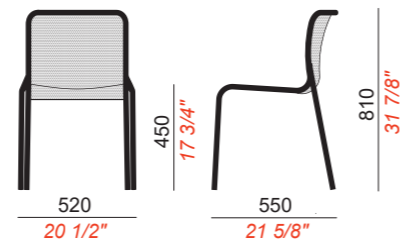
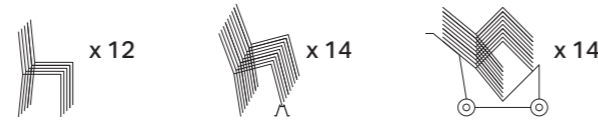

4 LEGS FRAME / CHÂSSIS À 4 PIEDS  
ESTRUCTURA 4 PATAS / GESTELL 4 BEINE

ITEMS PER BOX QUANTITÉ PAR EMBALLAGE CANTIDADES POR CAJA ANZAHL PRO VERPACKUNG	PACKAGING SIZES DIMENSIONS EMBALLAGE DIMENSIONES EMBALAJE VERPACKUNG MASSE	PACKAGING VOLUME VOLUME EMBALLAGE VOLUMEN EMBALAJE VERPACKUNG VOLUMEN	BOX WEIGHT POIDS EMBALLAGE PESO CAJA VERPACKUNG GEWICHT
4	66x61x86	0,35	17

\*METAL AND ALUMINIUM COLOURS: SEE ALTERNATIVES ON PAGE 120  
\*COULEURS MÉTAL ET ALUMINIUM : VOIR ALTERNATIVES À LA PAGE 120  
\*COLORES METAL Y ALUMINIO: VER ALTERNATIVAS EN LA PÁGINA 120  
\*METALL- UND ALUMINIUMFARBEN: SIEHE ALTERNATIVEN AUF SEITE 120

VARNISHED METAL COLOURS / COULEURS MÉTAL VERNI  
COLORES METAL BARNIZADO / LACKIERTE METALL FARBEN



BIANCO      SENAPE      VERDE SCURO      GRIGIO SCURO      MELANZANA      NERO

NCS 0500-N    NCS 2070 - Y10R    NCS 8010 - G10Y    NCS 7500 - N    NCS 5540 - Y90R    NCS 9000 - N

# Momo Net 2

Jeremiah Ferrarese, 2020

 MADE IN ITALY



OUTDOOR

TECHNICAL DETAILS / DÉTAILS TECHNIQUES / DETALLES TECNICOS / TECHNISCHE DATEN

FRAME: TUBULAR METAL 25 MM / CHÂSSIS: TUBE EN MÉTAL 25 MM  
ESTRUCTURA: TUBULAR EN METAL 25 MM / GESTELL: STAHLROHR 25 MM

SEAT/BACKREST: METAL MESH / COQUE: MAILLE MÉTALLIQUE  
CARCASA: MALLA METÁLICA / SITZ/RÜCKENLEHNE: METALLGEWEBE

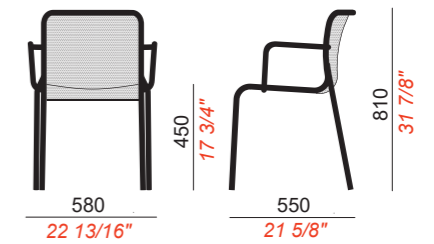
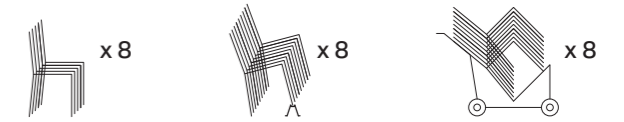

4 LEGS FRAME / CHÂSSIS À 4 PIEDS  
ESTRUCTURA 4 PATAS / GESTELL 4 BEINE

ITEMS PER BOX QUANTITÉ PAR EMBALLAGE CANTIDADES POR CAJA ANZAHL PRO VERPACKUNG	PACKAGING SIZES DIMENSIONS EMBALLAGE DIMENSIONES EMBALAJE VERPACKUNG MASSE	PACKAGING VOLUME VOLUME EMBALLAGE VOLUMEN EMBALAJE VERPACKUNG VOLUMEN	BOX WEIGHT POIDS EMBALLAGE PESO CAJA VERPACKUNG GEWICHT
4	66x61x86	0,35	19

\*METAL AND ALUMINIUM COLOURS: SEE ALTERNATIVES ON PAGE 120  
\*COULEURS MÉTAL ET ALUMINIUM : VOIR ALTERNATIVES À LA PAGE 120  
\*COLORES METAL Y ALUMINIO: VER ALTERNATIVAS EN LA PÁGINA 120  
\*METALL- UND ALUMINIUMFARBEN: SIEHE ALTERNATIVEN AUF SEITE 120

VARNISHED METAL COLOURS / COULEURS MÉTAL VERNI  
COLORES METAL BARNIZADO / LACKIERTE METALL FARBEN



BIANCO      SENAPE      VERDE SCURO      GRIGIO SCURO      MELANZANA      NERO

NCS 0500-N    NCS 2070 - Y10R    NCS 8010 - G10Y    NCS 7500 - N    NCS 5540 - Y90R    NCS 9000 - N

# Momo Net 3

Jeremiah Ferrarese, 2020

 MADE IN ITALY



OUTDOOR

**TECHNICAL DETAILS / DÉTAILS TECHNIQUES / DETALLES TECNICOS / TECHNISCHE DATEN**

**FRAME: TUBULAR METAL 25 MM / CHÂSSIS: TUBE EN MÉTAL 25 MM**  
**ESTRUCTURA: TUBULAR EN METAL 25 MM / GESTELL: STAHLROHR 25 MM**

**SEAT/BACKREST: METAL MESH / COQUE: MAILLE MÉTALLIQUE**  
**CARCASA: MALLA METÁLICA / SITZ/RÜCKENLEHNE: METALLGEWEBE**

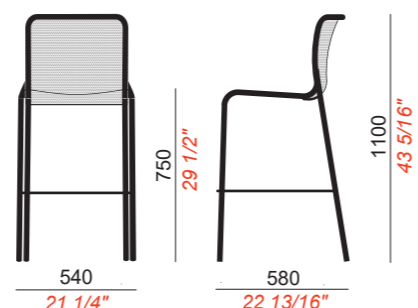
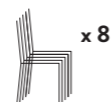

**4 LEGS FRAME H:750 / CHÂSSIS À 4 PIEDS H:750**  
**ESTRUCTURA 4 PATAS H:750 / GESTELL 4 BEINE H:750**

ITEMS PER BOX QUANTITÉ PAR EMBALLAGE CANTIDADES POR CAJA ANZAHL PRO VERPACKUNG	PACKAGING SIZES DIMENSIONS EMBALLAGE DIMENSIONES EMBALAJE VERPACKUNG MASSE	PACKAGING VOLUME VOLUME EMBALLAGE VOLUMEN EMBALAJE VERPACKUNG VOLUMEN	BOX WEIGHT POIDS EMBALLAGE PESO CAJA VERPACKUNG GEWICHT
2	68x62x120	0,50	19

\*METAL AND ALUMINIUM COLOURS: SEE ALTERNATIVES ON PAGE 120  
 \*COULEURS MÉTAL ET ALUMINIUM : VOIR ALTERNATIVES À LA PAGE 120  
 \*COLORES METAL Y ALUMINIO: VER ALTERNATIVAS EN LA PÁGINA 120  
 \*METALL- UND ALUMINIUMFARBEN: SIEHE ALTERNATIVEN AUF SEITE 120

**VARNISHED METAL COLOURS / COULEURS MÉTAL VERNI**  
**COLORES METAL BARNIZADO / LACKIERTE METALL FARBEN**



BIANCO

NCS 0500 - N



SENAPE

NCS 2070 - Y10R



VERDE SCURO

NCS 8010 - G10Y



GRIGIO SCURO

NCS 7500 - N



MELANZANA

NCS 5540 - Y90R



NERO

NCS 9000 - N







# Alfiere Basso

Alban Le Henry, 2019

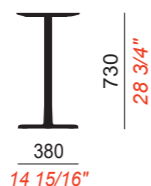

TECHNICAL DETAILS / DÉTAILS TECHNIQUES / DETALLES TECNICOS / TECHNISCHE DATEN

STEM: METAL / TIGE: MÉTAL / TALLO: METAL / AUFSATZ: AUS STAHL

BASE: CAST IRON / BASE: FONTE / BASE: HIERRO FUNDIDO / GESTELL: GUSSEISEN

TOP dim. MAX  
top size max  
top dim. max  
700x700  
Ø 800

VARNISHED METAL COLOURS / COULEURS MÉTAL VERNI / COLORES METAL BARNIZADO / LACKIERTE METALL FARBEN

White / Blanc  
Blanco / Weiss  
NCS 0500 - N

Black / Noir  
Negro / Schwartz  
NCS 9000 - N

FINISHING / FINITIONS  
ACABADOS / AUSFÜHRUNGEN

BASE / STEM  
BASE / TIGE  
BASE / TALLO  
GESTELL / AUFSATZ

VERNI  
VARNISHED  
BARNIZADO  
LACKIERT

# Alfiere Alto

Alban Le Henry, 2019

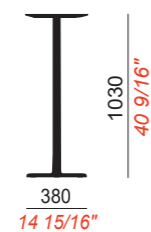

TECHNICAL DETAILS / DÉTAILS TECHNIQUES / DETALLES TECNICOS / TECHNISCHE DATEN

STEM: METAL / TIGE: MÉTAL / TALLO: METAL / AUFSATZ: AUS STAHL

BASE: CAST IRON / BASE: FONTE / BASE: HIERRO FUNDIDO / GESTELL: GUSSEISEN

TOP dim. MAX  
top size max  
top dim. max  
600x600  
Ø 600

VARNISHED METAL COLOURS / COULEURS MÉTAL VERNI / COLORES METAL BARNIZADO / LACKIERTE METALL FARBEN

White / Blanc  
Blanco / Weiss  
NCS 0500 - N

Black / Noir  
Negro / Schwartz  
NCS 9000 - N

FINISHING / FINITIONS  
ACABADOS / AUSFÜHRUNGEN

BASE / STEM  
BASE / TIGE  
BASE / TALLO  
GESTELL / AUFSATZ

VERNI  
VARNISHED  
BARNIZADO  
LACKIERT





# Stato Basso

Christoph Jenni, 2015

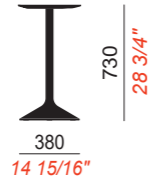



**TECHNICAL DETAILS / DÉTAILS TECHNIQUES / DETALLES TECNICOS / TECHNISCHE DATEN**

**STEM: METAL / TIGE: MÉTAL / TALLO: METAL / AUFSATZ: AUS STAHL**

**BASE: CAST IRON / BASE: FONTE / BASE: HIERRO FUNDIDO / GESTELL: GUSSEISEN**

**TOP dim. MAX  
top size max  
top dim. max  
700x700  
Ø 800**

**VARNISHED METAL COLOURS / COULEURS MÉTAL VERNI / COLORES METAL BARNIZADO / LACKIERTE METALL FARBEN**

	
White / Blanc Blanco / Weiss	Black / Noir Negro / Schwartz
NCS 0500 - N	NCS 9000 - N

**FINISHING / FINITIONS  
ACABADOS / AUSFÜHRUNGEN**

**BASE / STEM  
BASE / TIGE  
BASE / TALLO  
GESTELL / AUFSATZ**

**VERNI  
VARNISHED  
BARNIZADO  
LACKIERT**

# Stato Alto

Christoph Jenni, 2015

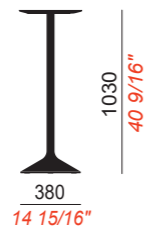



**TECHNICAL DETAILS / DÉTAILS TECHNIQUES / DETALLES TECNICOS / TECHNISCHE DATEN**

**STEM: METAL / TIGE: MÉTAL / TALLO: METAL / AUFSATZ: AUS STAHL**

**BASE: CAST IRON / BASE: FONTE / BASE: HIERRO FUNDIDO / GESTELL: GUSSEISEN**

**TOP dim. MAX  
top size max  
top dim. max  
600x600  
Ø 600**

**VARNISHED METAL COLOURS / COULEURS MÉTAL VERNI / COLORES METAL BARNIZADO / LACKIERTE METALL FARBEN**

	
White / Blanc Blanco / Weiss	Black / Noir Negro / Schwartz
NCS 0500 - N	NCS 9000 - N

**FINISHING / FINITIONS  
ACABADOS / AUSFÜHRUNGEN**

**BASE / STEM  
BASE / TIGE  
BASE / TALLO  
GESTELL / AUFSATZ**

**VERNI  
VARNISHED  
BARNIZADO  
LACKIERT**





# Edge G/T Basso

R&D Colos, 2020

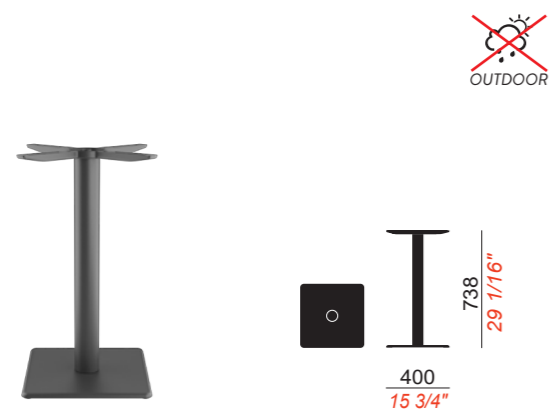

TECHNICAL DETAILS / DÉTAILS TECHNIQUES / DETALLES TECNICOS / TECHNISCHE DATEN

STEM: METAL / TIGE: MÉTAL / TALLO: METAL / AUFSATZ: AUS STAHL

BASE: CAST IRON / BASE: FONTE / BASE: HIERRO FUNDIDO / GESTELL: GUSSEISEN

TOP dim. MAX  
top size max  
top dim. max  
Ø 900

VARNISHED METAL COLOURS / COULEURS MÉTAL VERNI / COLORES METAL BARNIZADO / LACKIERTE METALL FARBEN

Black / Noir  
Negro / Schwartz  
NCS 9000 - N

FINISHING / FINITIONS  
ACABADOS / AUSFÜHRUNGEN

BASE / STEM  
BASE / TIGE  
BASE / TALLO  
GESTELL / AUFSATZ

VERNI  
VARNISHED  
BARNIZADO  
LACKIERT

# Edge S/T Basso

R&D Colos, 2020

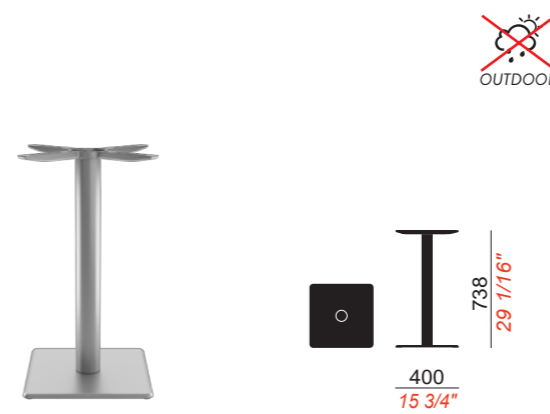

TECHNICAL DETAILS / DÉTAILS TECHNIQUES / DETALLES TECNICOS / TECHNISCHE DATEN

STEM: METAL / TIGE: MÉTAL / TALLO: METAL / AUFSATZ: AUS STAHL

BASE: METAL / BASE: MÉTAL / BASE: METAL / GESTELL: AUS METALL

TOP dim. MAX  
top size max  
top dim. max  
Ø 900

METAL COLOURS / COULEURS MÉTAL / COLORES METAL / METALL FARBEN

Satin / Satiné  
Satinado / Satiniert

FINISHING / FINITIONS  
ACABADOS / AUSFÜHRUNGEN

BASE / STEM  
BASE / TIGE  
BASE / TALLO  
GESTELL / AUFSATZ

SATIN FINISH  
SATINÉ  
SATINADO  
SATINIERT

# Edge G/T Alto

R&D Colos, 2020

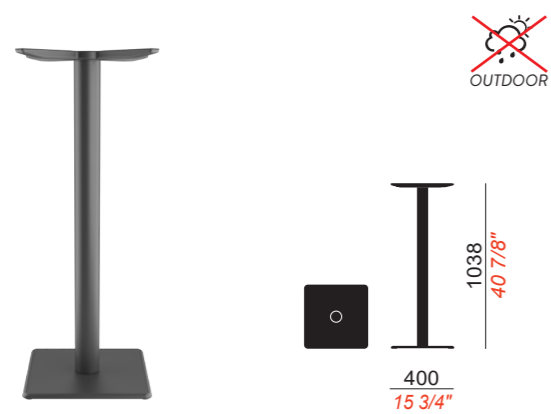

TECHNICAL DETAILS / DÉTAILS TECHNIQUES / DETALLES TECNICOS / TECHNISCHE DATEN

STEM: METAL / TIGE: MÉTAL / TALLO: METAL / AUFSATZ: AUS STAHL

BASE: CAST IRON / BASE: FONTE / BASE: HIERRO FUNDIDO / GESTELL: GUSSEISEN

TOP dim. MAX  
top size max  
top dim. max  
Ø 700

VARNISHED METAL COLOURS / COULEURS MÉTAL VERNI / COLORES METAL BARNIZADO / LACKIERTE METALL FARBEN

Black / Noir  
Negro / Schwartz  
NCS 9000 - N

FINISHING / FINITIONS  
ACABADOS / AUSFÜHRUNGEN

BASE / STEM  
BASE / TIGE  
BASE / TALLO  
GESTELL / AUFSATZ

VERNI  
VARNISHED  
BARNIZADO  
LACKIERT

# Edge S/T Alto

R&D Colos, 2020

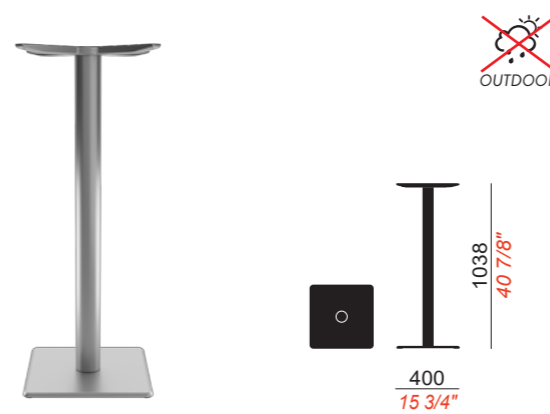

TECHNICAL DETAILS / DÉTAILS TECHNIQUES / DETALLES TECNICOS / TECHNISCHE DATEN

STEM: METAL / TIGE: MÉTAL / TALLO: METAL / AUFSATZ: AUS STAHL

BASE: METAL / BASE: MÉTAL / BASE: METAL / GESTELL: AUS METALL

TOP dim. MAX  
top size max  
top dim. max  
Ø 700

METAL COLOURS / COULEURS MÉTAL / COLORES METAL / METALL FARBEN

Satin / Satiné  
Satinado / Satiniert

FINISHING / FINITIONS  
ACABADOS / AUSFÜHRUNGEN

BASE / STEM  
BASE / TIGE  
BASE / TALLO  
GESTELL / AUFSATZ

SATIN FINISH  
SATINÉ  
SATINADO  
SATINIERT

# Edge G/Q Basso

R&D Colos, 2020

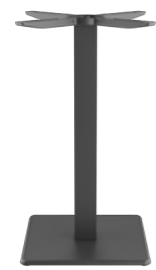
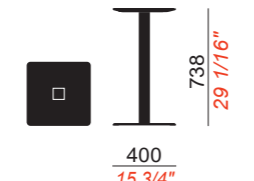
**OUTDOOR**

**TECHNICAL DETAILS / DÉTAILS TECHNIQUES / DETALLES TECNICOS / TECHNISCHE DATEN**

**STEM: METAL / TIGE: MÉTAL / TALLO: METAL / AUFSATZ: AUS STAHL**

**TOP dim. MAX top size max top dim. max 900x900**

**BASE: CAST IRON / BASE: FONTE / BASE: HIERRO FUNDIDO / GESTELL: GUSSEISEN**

**VARNISHED METAL COLOURS / COULEURS MÉTAL VERNI / COLORES METAL BARNIZADO / LACKIERTE METALL FARBEN**

Black / Noir  
Negro / Schwartz  
NCS 9000 - N

**FINISHING / FINITIONS**  
ACABADOS / AUSFÜHRUNGEN

BASE / STEM  
BASE / TIGE  
BASE / TALLO  
GESTELL / AUFSATZ

VERNI  
VARNISHED  
BARNIZADO  
LACKIERT

# Edge S/Q Basso

R&D Colos, 2020

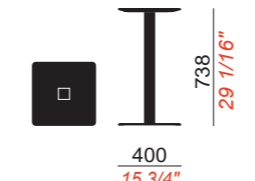
**OUTDOOR**

**TECHNICAL DETAILS / DÉTAILS TECHNIQUES / DETALLES TECNICOS / TECHNISCHE DATEN**

**STEM: METAL / TIGE: MÉTAL / TALLO: METAL / AUFSATZ: AUS STAHL**

**TOP dim. MAX top size max top dim. max 900x900**

**BASE: METAL / BASE: MÉTAL / BASE: METAL / GESTELL: AUS METALL**

**METAL COLOURS / COULEURS MÉTAL / COLORES METAL / METALL FARBEN**

Satin / Satiné  
Satinado / Satiniert

**FINISHING / FINITIONS**  
ACABADOS / AUSFÜHRUNGEN

BASE / STEM  
BASE / TIGE  
BASE / TALLO  
GESTELL / AUFSATZ

SATIN FINISH  
SATINÉ  
SATINADO  
SATINIERT

# Edge G/Q Alto

R&D Colos, 2020

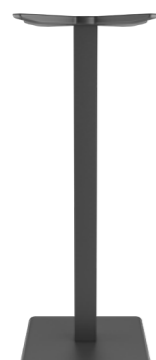
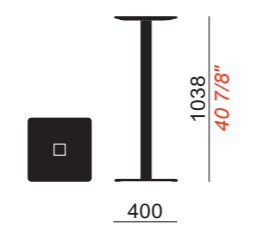
**OUTDOOR**

**TECHNICAL DETAILS / DÉTAILS TECHNIQUES / DETALLES TECNICOS / TECHNISCHE DATEN**

**STEM: METAL / TIGE: MÉTAL / TALLO: METAL / AUFSATZ: AUS STAHL**

**TOP dim. MAX top size max top dim. max 700x700**

**BASE: CAST IRON / BASE: FONTE / BASE: HIERRO FUNDIDO / GESTELL: GUSSEISEN**

**VARNISHED METAL COLOURS / COULEURS MÉTAL VERNI / COLORES METAL BARNIZADO / LACKIERTE METALL FARBEN**

Black / Noir  
Negro / Schwartz  
NCS 9000 - N

**FINISHING / FINITIONS**  
ACABADOS / AUSFÜHRUNGEN

BASE / STEM  
BASE / TIGE  
BASE / TALLO  
GESTELL / AUFSATZ

VERNI  
VARNISHED  
BARNIZADO  
LACKIERT

# Edge S/Q Alto

R&D Colos, 2020

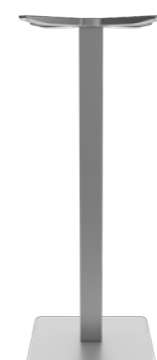
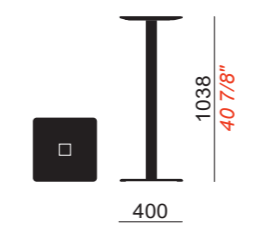
**OUTDOOR**

**TECHNICAL DETAILS / DÉTAILS TECHNIQUES / DETALLES TECNICOS / TECHNISCHE DATEN**

**STEM: METAL / TIGE: MÉTAL / TALLO: METAL / AUFSATZ: AUS STAHL**

**TOP dim. MAX top size max top dim. max 700x700**

**BASE: METAL / BASE: MÉTAL / BASE: METAL / GESTELL: AUS METALL**

**METAL COLOURS / COULEURS MÉTAL / COLORES METAL / METALL FARBEN**

Satin / Satiné  
Satinado / Satiniert

**FINISHING / FINITIONS**  
ACABADOS / AUSFÜHRUNGEN

BASE / STEM  
BASE / TIGE  
BASE / TALLO  
GESTELL / AUFSATZ

SATIN FINISH  
SATINÉ  
SATINADO  
SATINIERT

# Edge G/R Basso

R&D Colos, 2020



**OUTDOOR**

**TECHNICAL DETAILS / DÉTAILS TECHNIQUES / DETALLES TECNICOS / TECHNISCHE DATEN**

**STEM: METAL / TIGE: MÉTAL / TALLO: METAL / AUFSATZ: AUS STAHL**

**BASE: CAST IRON / BASE: FONTE / BASE: HIERRO FUNDIDO / GESTELL: GUSSEISEN**

**TOP dim. MAX top size max top dim. max 1400x800**

**VARNISHED METAL COLOURS / COULEURS MÉTAL VERNI / COLORES METAL BARNIZADO / LACKIERTE METALL FARBEN**

**Black / Noir Negro / Schwarz**

**NCS 9000 - N**

**FINISHING / FINITIONS**  
ACABADOS / AUSFÜHRUNGEN

**BASE / STEM**  
**BASE / TIGE**  
**BASE / TALLO**  
**GESTELL / AUFSATZ**

**VERNI**  
**VARNISHED**  
**BARNIZADO**  
**LACKIERT**

# Tops / Plateau

## Top / Platte

 **MADE IN ITALY**

SIZES DIMENSIONS MEDIDAS MABE		FINISHING / FINITIONS ACABADOS / AUSFÜHRUNGEN
○	Ø 600	<b>HPL WHITE / BLACK</b> <b>HPL BLANC / NOIR</b> <b>HPL BLANCO / NEGRO</b> <b>HPL WEISS &amp; SCHWARZ</b>
	Ø 700	
	Ø 800	
	Ø 900	
□	600x600	
	700x700	
	800x800	
	900x900	
□	700x600	
	1400x800	

**HPL COLOURS / COULEURS HPL**  
COLORES HPL / HPL FARBEN



White  
Blanc  
Blanco  
Weiss



Black  
Noir  
Negro  
Schwarz



Corten  
Corten  
Corten  
Corten



Oak  
Chêne  
Roble  
Eichenholz





# Ta 2.0 1-600

Jeremiah Ferrarese, 2020

 MADE IN ITALY



TECHNICAL DETAILS / DÉTAILS TECHNIQUES / DETALLES TECNICOS / TECHNISCHE DATEN

FRAME: TUBULAR METAL 35 MM / CHÂSSIS: TUBE EN MÉTAL 35 MM  
ESTRUCTURA: TUBULAR EN METAL 35 MM / GESTELL: STAHLROHR 35 MM

TOP: METAL SHEET OR HPL / PLATEAU: TÔLE OU HPL  
TOP: HOJA DE METAL O HPL / PLATTE: METALL ODER HPL

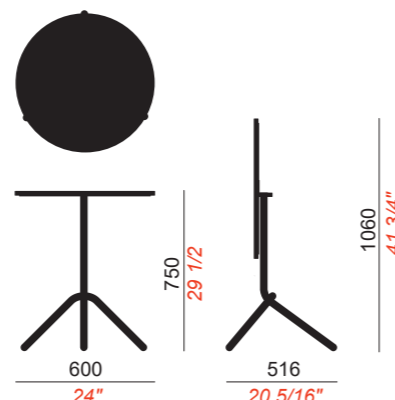

3 FEET BASE, TOP DIAM. 600 / BASE À 3 PIEDS, PLATEAU DIAM. 600  
BASE 3 PATAS, TOP DIAM. 600 / AUFSATZ AUF 3 FÜSSEN, PLATTE DURCHM. 600

## FINISHINGS / FINITIONS ACABADOS / AUSFÜHRUNGEN

BASE / BASE BASE / GESTELL	VARNISHED / VERNI BARNIZADO / LACKIERT
TOP / PLATEAU TOP / PLATTE	METAL SHEET / TÔLE HOJA DE METAL / BLECH
TOP / PLATEAU TOP / PLATTE	**HPL WHITE / BLACK **HPL BLANC / NOIR **HPL BLANCO / NEGRO **HPL WEISS / SCHWARZ
TOP / PLATEAU TOP / PLATTE	**HPL CORTEN / OAK **HPL CORTEN / CHÊNE **HPL CORTEN / ROBLE **HPL CORTEN / EICHENHOLZ

\*METAL AND ALUMINIUM COLOURS: SEE ALTERNATIVES ON PAGE 120  
\*COULEURS MÉTAL ET ALUMINIUM : VOIR ALTERNATIVES À LA PAGE 120  
\*COLORES METAL Y ALUMINIO: VER ALTERNATIVAS EN LA PÁGINA 120  
\*METALL- UND ALUMINIUMFARBEN: SIEHE ALTERNATIVEN AUF SEITE 120

\*\*For HPL colours please see page 93  
\*\*Couleurs HPL disponibles à page 93  
\*\*Para colores HPL ver pagina 93  
\*\*Für HPL Farbausführungen, s.S. 93

## VARNISHED METAL COLOURS / COULEURS MÉTAL VERNI COLORES METAL BARNIZADO / LACKIERTE METALL FARBEN



BIANCO TORRENTE SENAPE VERDE SCURO GRIGIO SCURO MELANZANA NERO

NCS 0500-N | NCS S 3005-G50Y | NCS 2070 - Y10R | NCS 8010 - G10Y | NCS 7500 - N | NCS 5540 - Y90R | NCS 9000 - N

# Ta 2.0 1-700

Jeremiah Ferrarese, 2020

 MADE IN ITALY



TECHNICAL DETAILS / DÉTAILS TECHNIQUES / DETALLES TECNICOS / TECHNISCHE DATEN

FRAME: TUBULAR METAL 35 MM / CHÂSSIS: TUBE EN MÉTAL 35 MM  
ESTRUCTURA: TUBULAR EN METAL 35 MM / GESTELL: STAHLROHR 35 MM

TOP: METAL SHEET OR HPL / PLATEAU: TÔLE OU HPL  
TOP: HOJA DE METAL O HPL / PLATTE: METALL ODER HPL

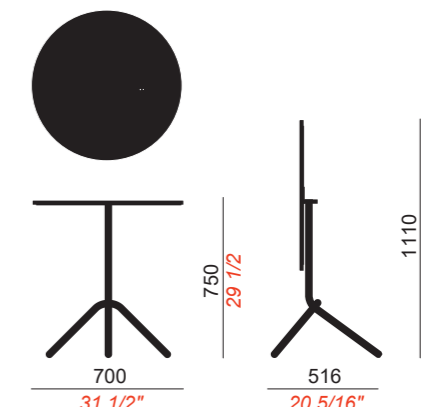

3 FEET BASE, TOP DIAM. 700 / BASE À 3 PIEDS, PLATEAU DIAM. 700  
BASE 3 PATAS, TOP DIAM. 700 / AUFSATZ AUF 3 FÜSSEN, PLATTE DURCHM. 700

## FINISHINGS / FINITIONS ACABADOS / AUSFÜHRUNGEN

BASE / BASE BASE / GESTELL	VARNISHED / VERNI BARNIZADO / LACKIERT
TOP / PLATEAU TOP / PLATTE	METAL SHEET / TÔLE HOJA DE METAL / BLECH
TOP / PLATEAU TOP / PLATTE	**HPL WHITE / BLACK **HPL BLANC / NOIR **HPL BLANCO / NEGRO **HPL WEISS / SCHWARZ
TOP / PLATEAU TOP / PLATTE	**HPL CORTEN / OAK **HPL CORTEN / CHÊNE **HPL CORTEN / ROBLE **HPL CORTEN / EICHENHOLZ

\*METAL AND ALUMINIUM COLOURS: SEE ALTERNATIVES ON PAGE 120  
\*COULEURS MÉTAL ET ALUMINIUM : VOIR ALTERNATIVES À LA PAGE 120  
\*COLORES METAL Y ALUMINIO: VER ALTERNATIVAS EN LA PÁGINA 120  
\*METALL- UND ALUMINIUMFARBEN: SIEHE ALTERNATIVEN AUF SEITE 120

\*\*For HPL colours please see page 93  
\*\*Couleurs HPL disponibles à page 93  
\*\*Para colores HPL ver pagina 93  
\*\*Für HPL Farbausführungen, s.S. 93

## VARNISHED METAL COLOURS / COULEURS MÉTAL VERNI COLORES METAL BARNIZADO / LACKIERTE METALL FARBEN



BIANCO TORRENTE SENAPE VERDE SCURO GRIGIO SCURO MELANZANA NERO

NCS 0500-N | NCS S 3005-G50Y | NCS 2070 - Y10R | NCS 8010 - G10Y | NCS 7500 - N | NCS 5540 - Y90R | NCS 9000 - N

# Ta 2.0 1/Q-600

Jeremiah Ferrarese, 2020

MADE IN ITALY



TECHNICAL DETAILS / DÉTAILS TECHNIQUES / DETALLES TECNICOS / TECHNISCHE DATEN

FRAME: TUBULAR METAL 35 MM / CHÂSSIS: TUBE EN MÉTAL 35 MM  
ESTRUCTURA: TUBULAR EN METAL 35 MM / GESTELL: STAHLROHR 35 MM

TOP: METAL SHEET OR HPL / PLATEAU: TÔLE OU HPL  
TOP: HOJA DE METAL O HPL / PLATTE: METALL ODER HPL

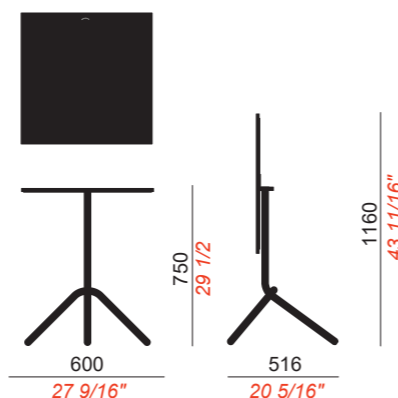

3 FEET BASE, TOP DIAM. 600 / BASE À 3 PIEDS, PLATEAU DIAM. 600  
BASE 3 PATAS, TOP DIAM. 600 / AUFSATZ AUF 3 FÜSSEN, PLATTE DURCHM. 600

## FINISHINGS / FINITIONS ACABADOS / AUSFÜHRUNGEN

BASE / BASE BASE / GESTELL	VARNISHED / VERNI BARNIZADO / LACKIERT
TOP / PLATEAU TOP / PLATTE	METAL SHEET / TÔLE HOJA DE METAL / BLECH
TOP / PLATEAU TOP / PLATTE	**HPL WHITE / BLACK **HPL BLANC / NOIR **HPL BLANCO / NEGRO **HPL WEISS / SCHWARZ
TOP / PLATEAU TOP / PLATTE	**HPL CORTEN / OAK **HPL CORTEN / CHÊNE **HPL CORTEN / ROBLE **HPL CORTEN / EICHENHOLZ

\*METAL AND ALUMINIUM COLOURS: SEE ALTERNATIVES ON PAGE 120  
\*COULEURS MÉTAL ET ALUMINIUM : VOIR ALTERNATIVES À LA PAGE 120  
\*COLORES METAL Y ALUMINIO: VER ALTERNATIVAS EN LA PÁGINA 120  
\*METALL- UND ALUMINIUMFARBEN: SIEHE ALTERNATIVEN AUF SEITE 120

\*\*For HPL colours please see page 93  
\*\*Couleurs HPL disponibles à page 93  
\*\*Para colores HPL ver pagina 93  
\*\*Für HPL Farbausführungen, s.S. 93

## VARNISHED METAL COLOURS / COULEURS MÉTAL VERNI COLORES METAL BARNIZADO / LACKIERTE METALL FARBEN



BIANCO TORRENTE SENAPE VERDE SCURO GRIGIO SCURO MELANZANA NERO

NCS 0500-N | NCS S 3005-G50Y | NCS 2070 - Y10R | NCS 8010 - G10Y | NCS 7500 - N | NCS 5540 - Y90R | NCS 9000 - N

# Ta 2.0 1/Q-700

Jeremiah Ferrarese, 2020

MADE IN ITALY



TECHNICAL DETAILS / DÉTAILS TECHNIQUES / DETALLES TECNICOS / TECHNISCHE DATEN

FRAME: TUBULAR METAL 35 MM / CHÂSSIS: TUBE EN MÉTAL 35 MM  
ESTRUCTURA: TUBULAR EN METAL 35 MM / GESTELL: STAHLROHR 35 MM

TOP: METAL SHEET OR HPL / PLATEAU: TÔLE OU HPL  
TOP: HOJA DE METAL O HPL / PLATTE: METALL ODER HPL

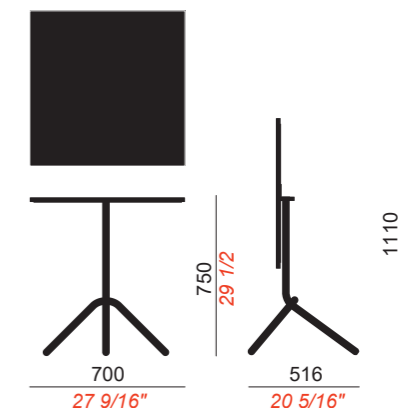

3 FEET BASE, TOP DIAM. 700 / BASE À 3 PIEDS, PLATEAU DIAM. 700  
BASE 3 PATAS, TOP DIAM. 700 / AUFSATZ AUF 3 FÜSSEN, PLATTE DURCHM. 700

## FINISHINGS / FINITIONS ACABADOS / AUSFÜHRUNGEN

BASE / BASE BASE / GESTELL	VARNISHED / VERNI BARNIZADO / LACKIERT
TOP / PLATEAU TOP / PLATTE	METAL SHEET / TÔLE HOJA DE METAL / BLECH
TOP / PLATEAU TOP / PLATTE	**HPL WHITE / BLACK **HPL BLANC / NOIR **HPL BLANCO / NEGRO **HPL WEISS / SCHWARZ
TOP / PLATEAU TOP / PLATTE	**HPL CORTEN / OAK **HPL CORTEN / CHÊNE **HPL CORTEN / ROBLE **HPL CORTEN / EICHENHOLZ

\*METAL AND ALUMINIUM COLOURS: SEE ALTERNATIVES ON PAGE 120  
\*COULEURS MÉTAL ET ALUMINIUM : VOIR ALTERNATIVES À LA PAGE 120  
\*COLORES METAL Y ALUMINIO: VER ALTERNATIVAS EN LA PÁGINA 120  
\*METALL- UND ALUMINIUMFARBEN: SIEHE ALTERNATIVEN AUF SEITE 120

\*\*For HPL colours please see page 93  
\*\*Couleurs HPL disponibles à page 93  
\*\*Para colores HPL ver pagina 93  
\*\*Für HPL Farbausführungen, s.S. 93

## VARNISHED METAL COLOURS / COULEURS MÉTAL VERNI COLORES METAL BARNIZADO / LACKIERTE METALL FARBEN



BIANCO TORRENTE SENAPE VERDE SCURO GRIGIO SCURO MELANZANA NERO

NCS 0500-N | NCS S 3005-G50Y | NCS 2070 - Y10R | NCS 8010 - G10Y | NCS 7500 - N | NCS 5540 - Y90R | NCS 9000 - N

# Ta 2.0 2-600

Jeremiah Ferrarese, 2020

MADE IN ITALY



OUTDOOR

TECHNICAL DETAILS / DÉTAILS TECHNIQUES / DETALLES TECNICOS / TECHNISCHE DATEN

FRAME: TUBULAR METAL 35 MM / CHÂSSIS: TUBE EN MÉTAL 35 MM  
ESTRUCTURA: TUBULAR EN METAL 35 MM / GESTELL: STAHLROHR 35 MM

TOP: METAL SHEET OR HPL / PLATEAU: TÔLE OU HPL  
TOP: HOJA DE METAL O HPL / PLATTE: METALL ODER HPL

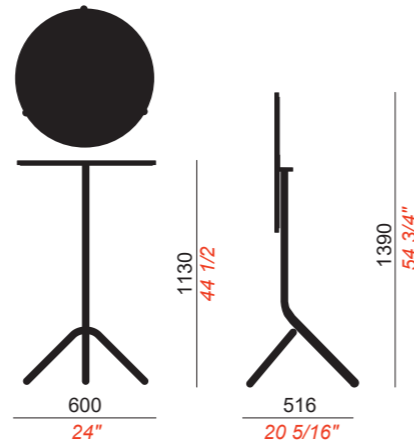

3 FEET BASE, TOP DIAM. 600 / BASE À 3 PIEDS, PLATEAU DIAM. 600  
BASE 3 PATAS, TOP DIAM. 600 / AUFSATZ AUF 3 FÜSSEN, PLATTE DURCHM. 600

## FINISHINGS / FINITIONS ACABADOS / AUSFÜHRUNGEN

BASE / BASE BASE / GESTELL	VARNISHED / VERNI BARNIZADO / LACKIERT
TOP / PLATEAU TOP / PLATTE	METAL SHEET / TÔLE HOJA DE METAL / BLECH
TOP / PLATEAU TOP / PLATTE	**HPL WHITE / BLACK **HPL BLANC / NOIR **HPL BLANCO / NEGRO **HPL WEISS / SCHWARZ
TOP / PLATEAU TOP / PLATTE	**HPL CORTEN / OAK **HPL CORTEN / CHÊNE **HPL CORTEN / ROBLE **HPL CORTEN / EICHENHOLZ

\*METAL AND ALUMINIUM COLOURS: SEE ALTERNATIVES ON PAGE 120  
\*COULEURS MÉTAL ET ALUMINIUM : VOIR ALTERNATIVES À LA PAGE 120  
\*COLORES METAL Y ALUMINIO: VER ALTERNATIVAS EN LA PÁGINA 120  
\*METALL- UND ALUMINIUMFARBEN: SIEHE ALTERNATIVEN AUF SEITE 120

\*\*For HPL colours please see page 93  
\*\*Couleurs HPL disponibles à page 93  
\*\*Para colores HPL ver pagina 93  
\*\*Für HPL Farbausführungen, s.S. 93

## VARNISHED METAL COLOURS / COULEURS MÉTAL VERNI COLORES METAL BARNIZADO / LACKIERTE METALL FARBEN



BIANCO TORRENTE SENAPE VERDE SCURO GRIGIO SCURO MELANZANA NERO

NCS 0500-N | NCS S 3005-G50Y | NCS 2070 - Y10R | NCS 8010 - G10Y | NCS 7500 - N | NCS 5540 - Y90R | NCS 9000 - N

# Ta 2.0 2/Q-600

Jeremiah Ferrarese, 2020

MADE IN ITALY



OUTDOOR

TECHNICAL DETAILS / DÉTAILS TECHNIQUES / DETALLES TECNICOS / TECHNISCHE DATEN

FRAME: TUBULAR METAL 35 MM / CHÂSSIS: TUBE EN MÉTAL 35 MM  
ESTRUCTURA: TUBULAR EN METAL 35 MM / GESTELL: STAHLROHR 35 MM

TOP: METAL SHEET OR HPL / PLATEAU: TÔLE OU HPL  
TOP: HOJA DE METAL O HPL / PLATTE: METALL ODER HPL

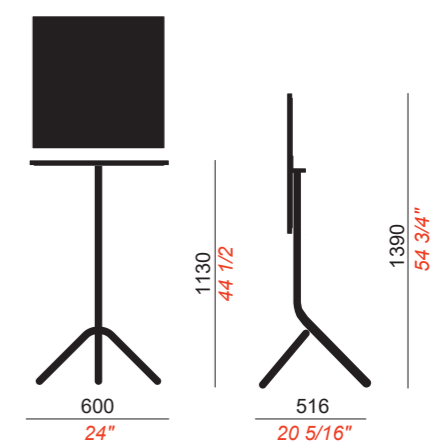

3 FEET BASE, TOP DIAM. 600 / BASE À 3 PIEDS, PLATEAU DIAM. 600  
BASE 3 PATAS, TOP DIAM. 600 / AUFSATZ AUF 3 FÜSSEN, PLATTE DURCHM. 600

## FINISHINGS / FINITIONS ACABADOS / AUSFÜHRUNGEN

BASE / BASE BASE / GESTELL	VARNISHED / VERNI BARNIZADO / LACKIERT
TOP / PLATEAU TOP / PLATTE	METAL SHEET / TÔLE HOJA DE METAL / BLECH
TOP / PLATEAU TOP / PLATTE	**HPL WHITE / BLACK **HPL BLANC / NOIR **HPL BLANCO / NEGRO **HPL WEISS / SCHWARZ
TOP / PLATEAU TOP / PLATTE	**HPL CORTEN / OAK **HPL CORTEN / CHÊNE **HPL CORTEN / ROBLE **HPL CORTEN / EICHENHOLZ

\*METAL AND ALUMINIUM COLOURS: SEE ALTERNATIVES ON PAGE 120  
\*COULEURS MÉTAL ET ALUMINIUM : VOIR ALTERNATIVES À LA PAGE 120  
\*COLORES METAL Y ALUMINIO: VER ALTERNATIVAS EN LA PÁGINA 120  
\*METALL- UND ALUMINIUMFARBEN: SIEHE ALTERNATIVEN AUF SEITE 120

\*\*For HPL colours please see page 93  
\*\*Couleurs HPL disponibles à page 93  
\*\*Para colores HPL ver pagina 93  
\*\*Für HPL Farbausführungen, s.S. 93

## VARNISHED METAL COLOURS / COULEURS MÉTAL VERNI COLORES METAL BARNIZADO / LACKIERTE METALL FARBEN



BIANCO TORRENTE SENAPE VERDE SCURO GRIGIO SCURO MELANZANA NERO

NCS 0500-N | NCS S 3005-G50Y | NCS 2070 - Y10R | NCS 8010 - G10Y | NCS 7500 - N | NCS 5540 - Y90R | NCS 9000 - N

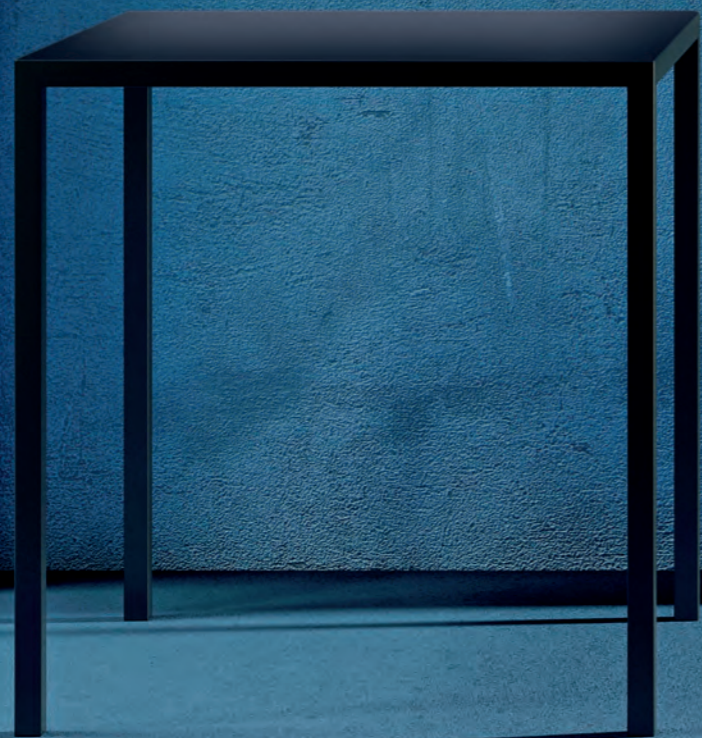

# Qu 600

R&D Colos, 2022

 MADE IN ITALY



OUTDOOR

TECHNICAL DETAILS / DÉTAILS TECHNIQUES / DETALLES TECNICOS / TECHNISCHE DATEN

FRAME: METAL SHEET / CHÂSSIS: TÔLE  
ESTRUCTURA: HOJA DE METAL / GESTELL: METALL

TOP: METAL SHEET / PLATEAU: TÔLE  
TOP: HOJA DE METAL / PLATTE: METALL

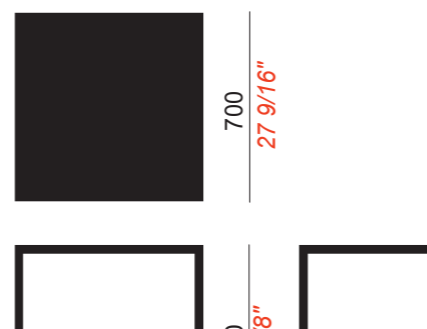
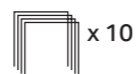

TABLE 600X600 / TABLEAU 600X600  
MESA 600X600 / TISCH 600X600

# Qu 700

R&D Colos, 2020

 MADE IN ITALY



OUTDOOR

TECHNICAL DETAILS / DÉTAILS TECHNIQUES / DETALLES TECNICOS / TECHNISCHE DATEN

FRAME: METAL SHEET / CHÂSSIS: TÔLE  
ESTRUCTURA: HOJA DE METAL / GESTELL: METALL

TOP: METAL SHEET / PLATEAU: TÔLE  
TOP: HOJA DE METAL / PLATTE: METALL

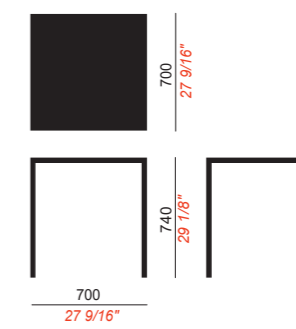

TABLE 700X700 / TABLEAU 700X700  
MESA 700X700 / TISCH 700X700

\*METAL AND ALUMINIUM COLOURS: SEE ALTERNATIVES ON PAGE 120  
\*COULEURS MÉTAL ET ALUMINIUM : VOIR ALTERNATIVES À LA PAGE 120  
\*COLORES METAL Y ALUMINIO: VER ALTERNATIVAS EN LA PÁGINA 120  
\*METALL- UND ALUMINIUMFARBEN: SIEHE ALTERNATIVEN AUF SEITE 120

VARNISHED METAL COLOURS / COULEURS MÉTAL VERNI  
COLORES METAL BARNIZADO / LACKIERTE METALL FARBEN



BIANCO TORRENTE SENAPE VERDE SCURO GRIGIO SCURO MELANZANA NERO

NCS 0500-N | NCS S 3005-G50Y | NCS 2070 - Y10R | NCS 8010 - G10Y | NCS 7500 - N | NCS 5540 - Y90R | NCS 9000 - N

\*METAL AND ALUMINIUM COLOURS: SEE ALTERNATIVES ON PAGE 120  
\*COULEURS MÉTAL ET ALUMINIUM : VOIR ALTERNATIVES À LA PAGE 120  
\*COLORES METAL Y ALUMINIO: VER ALTERNATIVAS EN LA PÁGINA 120  
\*METALL- UND ALUMINIUMFARBEN: SIEHE ALTERNATIVEN AUF SEITE 120

VARNISHED METAL COLOURS / COULEURS MÉTAL VERNI  
COLORES METAL BARNIZADO / LACKIERTE METALL FARBEN



BIANCO TORRENTE SENAPE VERDE SCURO GRIGIO SCURO MELANZANA NERO

NCS 0500-N | NCS S 3005-G50Y | NCS 2070 - Y10R | NCS 8010 - G10Y | NCS 7500 - N | NCS 5540 - Y90R | NCS 9000 - N

# Qu 800

R&D Colos, 2020

 MADE IN ITALY



OUTDOOR

TECHNICAL DETAILS / DÉTAILS TECHNIQUES / DETALLES TECNICOS / TECHNISCHE DATEN

FRAME: METAL SHEET / CHÂSSIS: TÔLE  
ESTRUCTURA: HOJA DE METAL / GESTELL: METALL

TOP: METAL SHEET / PLATEAU: TÔLE  
TOP: HOJA DE METAL / PLATTE: METALL



x 10

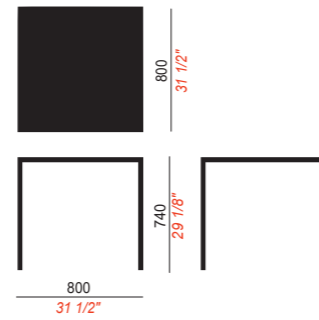

TABLE 800X800 / TABLEAU 800X800  
MESA 800X800 / TISCH 800X800

\*METAL AND ALUMINIUM COLOURS: SEE ALTERNATIVES ON PAGE 120  
\*COULEURS MÉTAL ET ALUMINIUM : VOIR ALTERNATIVES À LA PAGE 120  
\*COLORES METAL Y ALUMINIO: VER ALTERNATIVAS EN LA PÁGINA 120  
\*METALL- UND ALUMINIUMFARBEN: SIEHE ALTERNATIVEN AUF SEITE 120

VARNISHED METAL COLOURS / COULEURS MÉTAL VERNI  
COLORES METAL BARNIZADO / LACKIERTE METALL FARBEN



BIANCO

NCS 0500-N



TORRENTE

NCS S 3005-G50Y



SENAPE

NCS 2070 - Y10R



VERDE SCURO

NCS 8010 - G10Y



GRIGIO SCURO

NCS 7500 - N



MELANZANA

NCS 5540 - Y90R



NERO

NCS 9000 - N







# Vu B/T 1100

Jeremiah Ferrarese, 2019

 MADE IN ITALY



TECHNICAL DETAILS / DÉTAILS TECHNIQUES / DETALLES TECNICOS / TECHNISCHE DATEN

FRAME: METAL / CHÂSSIS: MÉTAL  
ESTRUCTURA: METAL / GESTELL: AUS METALL

TOP: MDF OR HPL / PLATEAU: MDF OU HPL  
TOP: MDF O HPL / PLATTE: MDF ODER HPL

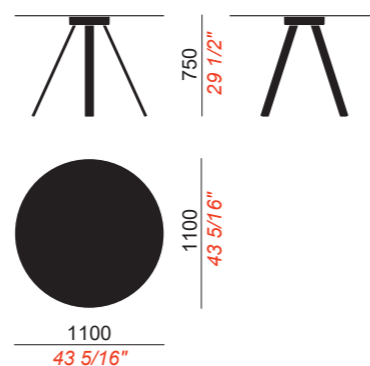

TOP DIAM. 1100 / PLATEAU DIAM. 1100  
TOP DIÁM. 1100 / PLATTE DURCHM. 1100

## FINISHINGS / FINITIONS ACABADOS / AUSFÜHRUNGEN

BASE / BASE BASE / GESTELL	VARNISHED / VERNI BARNIZADO / LACKIERT
TOP / PLATEAU TOP / PLATTE	HPL
TOP / PLATEAU TOP / PLATTE	MDF

## BASE COLOURS / COULEURS BASE COLORES ESTRUCTURA / FARBEN GESTELL



BIANCO NERO

NCS 0500-N NCS 9000 - N

## TOP COLOURS / COULEURS PLATEAU COLORES TOP / FARBEN PLATTE



BIANCO NERO Oak / Chêne  
Roble / Eichenholz

HPL HPL MDF

# Vu B/T 1300

Jeremiah Ferrarese, 2019

 MADE IN ITALY



TECHNICAL DETAILS / DÉTAILS TECHNIQUES / DETALLES TECNICOS / TECHNISCHE DATEN

FRAME: METAL / CHÂSSIS: MÉTAL  
ESTRUCTURA: METAL / GESTELL: AUS METALL

TOP: MDF OR HPL / PLATEAU: MDF OU HPL  
TOP: MDF O HPL / PLATTE: MDF ODER HPL

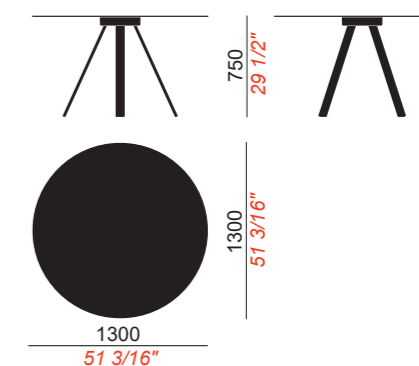

TOP DIAM. 1300 / PLATEAU DIAM. 1300  
TOP DIÁM. 1300 / PLATTE DURCHM. 1300

## FINISHINGS / FINITIONS ACABADOS / AUSFÜHRUNGEN

BASE / BASE BASE / GESTELL	VARNISHED / VERNI BARNIZADO / LACKIERT
TOP / PLATEAU TOP / PLATTE	HPL
TOP / PLATEAU TOP / PLATTE	MDF

## BASE COLOURS / COULEURS BASE COLORES ESTRUCTURA / FARBEN GESTELL

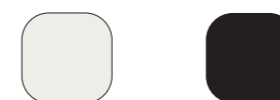

BIANCO NERO

NCS 0500-N NCS 9000 - N

## TOP COLOURS / COULEURS PLATEAU COLORES TOP / FARBEN PLATTE



BIANCO NERO Oak / Chêne  
Roble / Eichenholz

HPL HPL MDF

# Vu B/Q 900

Jeremiah Ferrarese, 2019

 MADE IN ITALY



OUTDOOR

TECHNICAL DETAILS / DÉTAILS TECHNIQUES / DETALLES TECNICOS / TECHNISCHE DATEN

FRAME: METAL / CHÂSSIS: MÉTAL  
ESTRUCTURA: METAL / GESTELL: AUS METALL

TOP: MDF OR HPL / PLATEAU: MDF OU HPL  
TOP: MDF O HPL / PLATTE: MDF ODER HPL

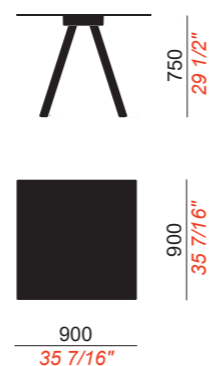

TOP DIAM. 900 / PLATEAU DIAM. 900  
TOP DIÁM. 900 / PLATTE DURCHM. 900

## FINISHINGS / FINITIONS ACABADOS / AUSFÜHRUNGEN

BASE / BASE BASE / GESTELL	VARNISHED / VERNI BARNIZADO / LACKIERT
TOP / PLATEAU TOP / PLATTE	*HPL WHITE / BLACK *HPL BLANC / NOIR *HPL BLANCO / NEGRO *HPL WEISS / SCHWARZ
TOP / PLATEAU TOP / PLATTE	*HPL CORTEN / OAK *HPL CORTEN / CHÊNE *HPL CORTEN / ROBLE *HPL CORTEN / EICHENHOLZ
TOP / PLATEAU TOP / PLATTE	MDF

BASE COLOURS / COULEURS BASE  
COLORES ESTRUCTURA / FARBEN GESTELL



BIANCO

NCS 0500-N



NERO

NCS 9000 - N



CORTEN

HPL



ROVERE

HPL



BIANCO

HPL



NERO

HPL



Oak / Chêne  
Roble / Eichenholz

MDF

# Vu B/R 1600

Jeremiah Ferrarese, 2019

 MADE IN ITALY



OUTDOOR

TECHNICAL DETAILS / DÉTAILS TECHNIQUES / DETALLES TECNICOS / TECHNISCHE DATEN

FRAME: METAL / CHÂSSIS: MÉTAL  
ESTRUCTURA: METAL / GESTELL: AUS METALL

TOP: HPL / PLATEAU: HPL  
TOP: HPL / PLATTE: HPL

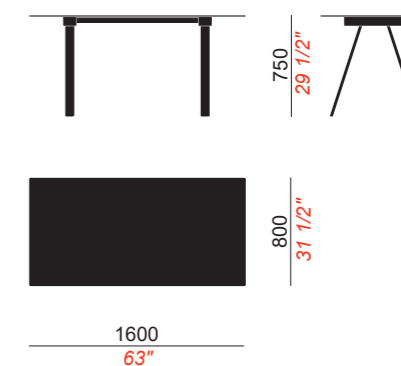

TOP DIAM. 1600X800 / PLATEAU DIAM. 1600x800  
TOP DIÁM. 1600X800 / PLATTE DURCHM. 1600X800

## FINISHINGS / FINITIONS ACABADOS / AUSFÜHRUNGEN

BASE / BASE BASE / GESTELL	VARNISHED / VERNI BARNIZADO / LACKIERT
TOP / PLATEAU TOP / PLATTE	HPL

BASE COLOURS / COULEURS BASE  
COLORES ESTRUCTURA / FARBEN GESTELL



BIANCO

NCS 0500-N



NERO

NCS 9000 - N

TOP COLOURS / COULEURS PLATEAU  
COLORES TOP / FARBEN PLATTE



BIANCO

HPL



NERO

HPL

# Vu B/R 2000

Jeremiah Ferrarese, 2019

 MADE IN ITALY



OUTDOOR

TECHNICAL DETAILS / DÉTAILS TECHNIQUES / DETALLES TECNICOS / TECHNISCHE DATEN

FRAME: METAL / CHÂSSIS: MÉTAL  
ESTRUCTURA: METAL / GESTELL: AUS METALL

TOP: HPL / PLATEAU: HPL  
TOP: HPL / PLATTE: HPL

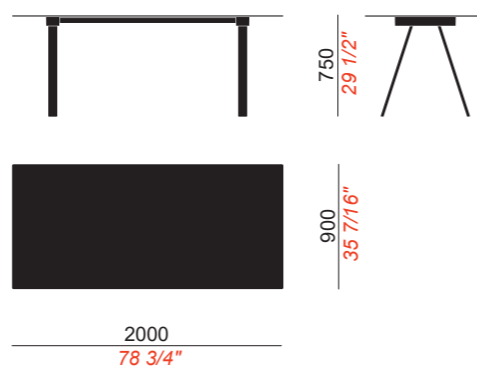

TOP DIAM. 2000X900 / PLATEAU DIAM. 2000X900  
TOP DIÁM. 2000X900 / PLATTE DURCHM. 2000X900

## FINISHINGS / FINITIONS ACABADOS / AUSFÜHRUNGEN

BASE / BASE BASE / GESTELL	VARNISHED / VERNI BARNIZADO / LACKIERT
TOP / PLATEAU TOP / PLATTE	HPL

BASE COLOURS / COULEURS BASE  
COLORES ESTRUCTURA / FARBEN GESTELL



BIANCO NERO

TOP COLOURS / COULEURS PLATEAU  
COLORES TOP / FARBEN PLATTE

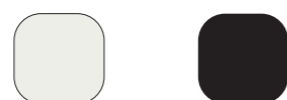

BIANCO NERO

NCS 0500-N	NCS 9000 - N		HPL	HPL	
------------	--------------	--	-----	-----	--

# Vu B/R 2400

Jeremiah Ferrarese, 2019

 MADE IN ITALY



OUTDOOR

TECHNICAL DETAILS / DÉTAILS TECHNIQUES / DETALLES TECNICOS / TECHNISCHE DATEN

FRAME: METAL / CHÂSSIS: MÉTAL  
ESTRUCTURA: METAL / GESTELL: AUS METALL

TOP: HPL / PLATEAU: HPL  
TOP: HPL / PLATTE: HPL

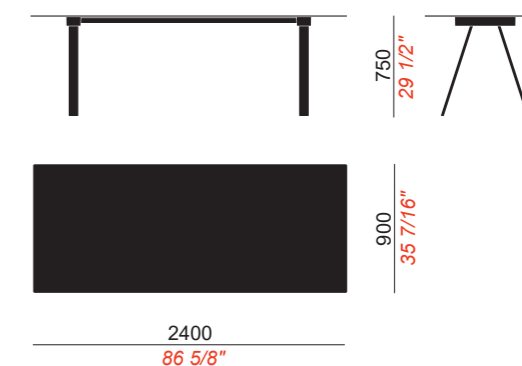

TOP DIAM. 2400X900 / PLATEAU DIAM. 2400X900  
TOP DIÁM. 2400X900 / PLATTE DURCHM. 2400X900

## FINISHINGS / FINITIONS ACABADOS / AUSFÜHRUNGEN

BASE / BASE BASE / GESTELL	VARNISHED / VERNI BARNIZADO / LACKIERT
TOP / PLATEAU TOP / PLATTE	HPL

BASE COLOURS / COULEURS BASE  
COLORES ESTRUCTURA / FARBEN GESTELL

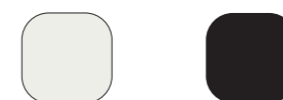

BIANCO NERO

TOP COLOURS / COULEURS PLATEAU  
COLORES TOP / FARBEN PLATTE



BIANCO NERO

NCS 0500-N	NCS 9000 - N		HPL	HPL	
------------	--------------	--	-----	-----	--

# Vu A/R 1600

Jeremiah Ferrarese, 2019

 MADE IN ITALY



OUTDOOR

TECHNICAL DETAILS / DÉTAILS TECHNIQUES / DETALLES TECNICOS / TECHNISCHE DATEN

FRAME: METAL / CHÂSSIS: MÉTAL  
ESTRUCTURA: METAL / GESTELL: AUS METALL

TOP: HPL / PLATEAU: HPL  
TOP: HPL / PLATTE: HPL

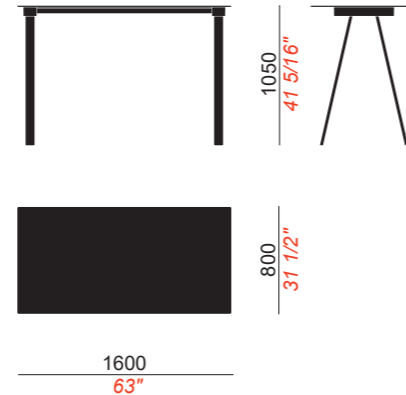

TOP DIAM. 1600X800 / PLATEAU DIAM. 1600X800  
TOP DIÁM. 1600X800 / PLATTE DURCHM. 1600X800

## FINISHINGS / FINITIONS ACABADOS / AUSFÜHRUNGEN

BASE / BASE BASE / GESTELL	VARNISHED / VERNI BARNIZADO / LACKIERT
TOP / PLATEAU TOP / PLATTE	HPL

BASE COLOURS / COULEURS BASE  
COLORES ESTRUCTURA / FARBEN GESTELL



BIANCO



NERO

TOP COLOURS / COULEURS PLATEAU  
COLORES TOP / FARBEN PLATTE



BIANCO



NERO

NCS 0500-N

NCS 9000 - N

HPL

HPL

# Vu A/R 2000

Jeremiah Ferrarese, 2019

 MADE IN ITALY



OUTDOOR

TECHNICAL DETAILS / DÉTAILS TECHNIQUES / DETALLES TECNICOS / TECHNISCHE DATEN

FRAME: METAL / CHÂSSIS: MÉTAL  
ESTRUCTURA: METAL / GESTELL: AUS METALL

TOP: HPL / PLATEAU: HPL  
TOP: HPL / PLATTE: HPL

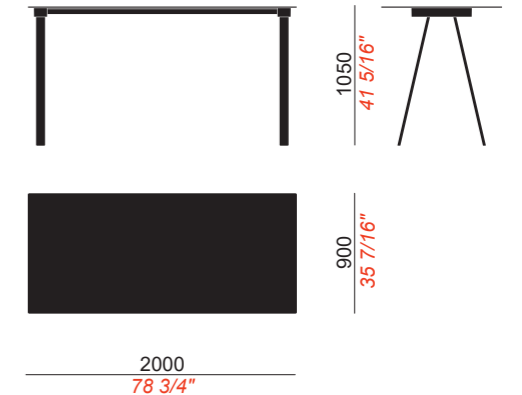

TOP DIAM. 2000X900 / PLATEAU DIAM. 2000X900  
TOP DIÁM. 2000X900 / PLATTE DURCHM. 2000X900

## FINISHINGS / FINITIONS ACABADOS / AUSFÜHRUNGEN

BASE / BASE BASE / GESTELL	VARNISHED / VERNI BARNIZADO / LACKIERT
TOP / PLATEAU TOP / PLATTE	HPL

BASE COLOURS / COULEURS BASE  
COLORES ESTRUCTURA / FARBEN GESTELL



BIANCO



NERO

TOP COLOURS / COULEURS PLATEAU  
COLORES TOP / FARBEN PLATTE



BIANCO



NERO

NCS 0500-N

NCS 9000 - N

HPL

HPL

# Accessories / Accessoires Accesorios/ Zubehörteile



ERCOLINA



TROLLEY / CHARIOT  
CARRITO / WAGEN

# Ercolina

R&D Colos, 2020

 MADE IN ITALY



TECHNICAL DETAILS / DÉTAILS TECHNIQUES / DETALLES  
TECNICOS / TECHNISCHE DATEN

FRAME: METAL SHEET / CHÂSSIS: TÔLE  
ESTRUCTURA: HOJA DE METAL / GESTELL: METALL



FINISHINGS / FINITIONS  
ACABADOS / AUSFÜHRUNGEN

FRAME: ALUMINUM SHEET / CHÂSSIS: TÔLE D'ALUMINIUM  
ESTRUCTURA: HOJA DE ALUMINIO / AUS ALUMINIUM

# Trolley / Chariot / Carrito / Wagen



TECHNICAL DETAILS / DÉTAILS TECHNIQUES / DETALLES TECNICOS /  
TECHNISCHE DATEN

FRAME: METAL SHEET / CHÂSSIS: TÔLE  
ESTRUCTURA: HOJA DE METAL / GESTELL: METALL



FINISHINGS / FINITIONS  
ACABADOS / AUSFÜHRUNGEN

METAL / MÉTAL  
METAL / AUS METALL

**Metal and Aluminium**  
**Couleurs du métal et de l'aluminium**  
**Colores metal y aluminio**  
**Metall- und Aluminiumfarben**

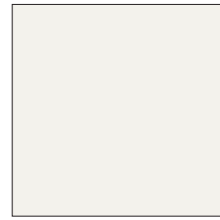

**BIANCO**  
NCS 0500-N



**TRAVERTINO**  
NCS S 2005-Y



**TORRENTE**  
NCS S 3005-G50Y



**GRIGIO CALDO**  
NCS 6005 - Y20R



**SENAPE**  
NCS 2070 - Y10R



**ROSSO**  
NCS 1085-Y90R



**TERRACOTTA**  
NCS S 3560-Y70R



**MELANZANA**  
NCS 5540 - Y90R



**VERDE SCURO**  
NCS 8010 - G10Y



**BLU SCURO**  
NCS 6030 - R80B



**GRIGIO SCURO**  
NCS 7500 - N



**NERO**  
NCS 9000 - N

[www.colos.it](http://www.colos.it)

